

MXP32P Profiled Rail Bearing 32mm (1-1/4 inch) Bore

Models: MXP32PTP MXP32PGP MXP32PNP
 MXP32PST MXP32PSG MXP32PSN
 Both Metric and Inch models

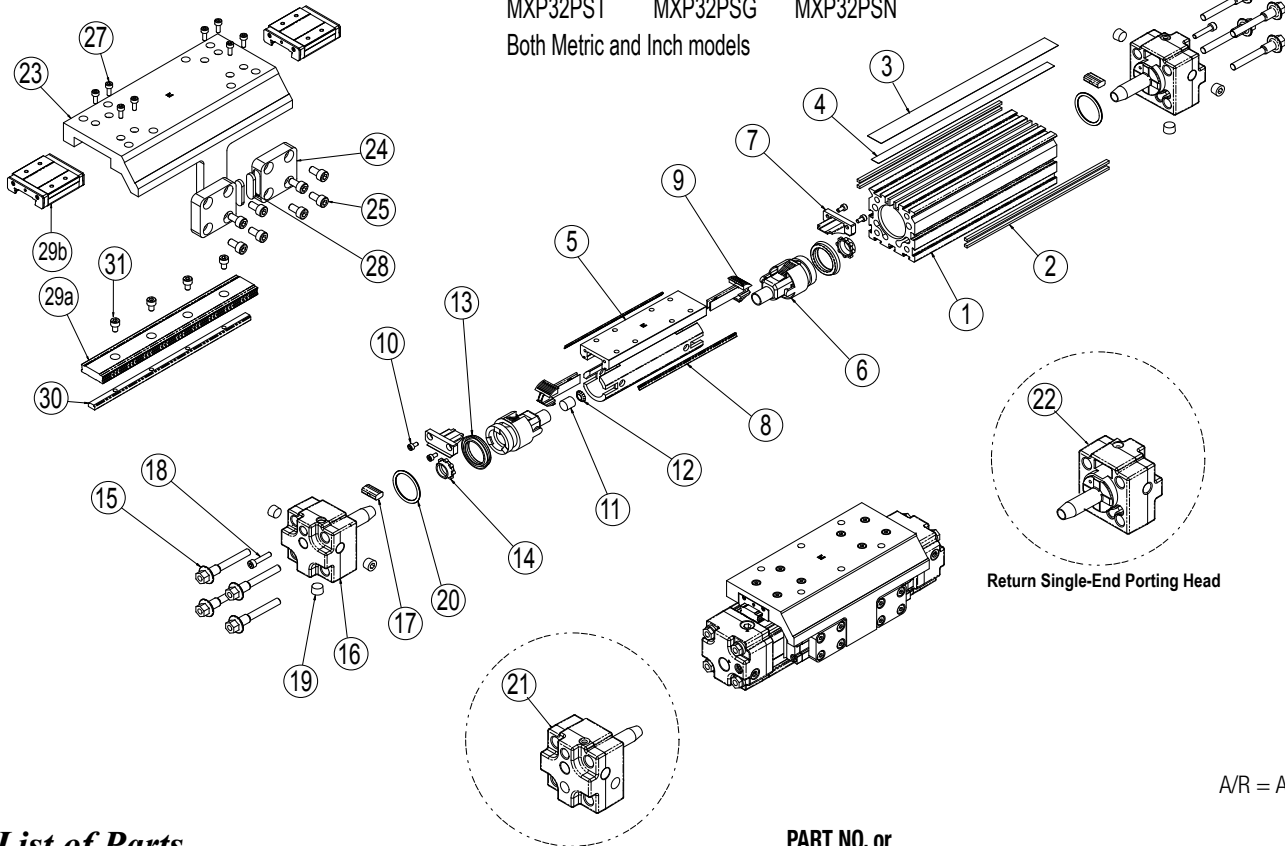

A/R = As Required

List of Parts

ITEM	PART NO. or CONFIG. CODE	DESCRIPTION	QTY.
1	RTBMXP32P	Replacement Tube (8132-1010) Specify Stroke	A/R
2	NMBMXP32P	Replacement Magnet Band (8132-1019) Specify Stroke	4A/R
3 ¹	NDBMXP32P	Replacement Dust Band (8132-1018) Specify Stroke	A/R
4 ¹	NSBMXP32P	Replacement Seal Band (8132-1017) Specify Stroke	A/R
5	8132-1012	Piston Bracket (metric)	1
	8132-1512	Piston Bracket (inch)	
6	8132-1005	Piston	2
7 ¹	8132-1006	End Cap	2
8 ¹	8132-1059	Wiper	2
9 ¹	8132-1007	Band Ramp	2
10	0601-1038	Socket Head Cap Screw	4
11	8125-1058	Magnet	1
12	8125-1072	Lock Washer	1
13 ¹	0912-1009	U-Cup	2
14 ¹	0912-1006	Cushion Seal	2
15	4512-1011	Head Screw (metric)	8
	0512-1011	Head Screw (inch)	
	8132-9001	Head Assy, NPT	
16	8132-9006	Head Assy, BSPT Metric Taper	2
	8132-9007	Head Assy, ISO Metric Parallel	
17 ²	8132-1039	Band Clamp	2
18 ²	2212-1094	Screw	2

ITEM	PART NO. or CONFIG. CODE	DESCRIPTION	QTY.
19 ²	1014-1065	Pipe Fitting Plug, 1/8-27 NPTF	6
	4910-1002	Pipe Fitting Plug, 1/8-28	
	5910-1006	Pipe Fitting Plug, G 1/8	
20 ^{1,2}	8132-1079	O-Ring	2
21 ³	8132-9002	Head Assy, NPT Single-end Porting	1
	8132-9008	Head Assy, BSPT Metric Taper, Single-end Porting	
	8132-9009	Head Assy, ISO Metric Parallel, Single-end Porting	
22 ³	8132-9003	Head Assy, Return Single-end Porting	1
23	8132-1021	Carrier (metric)	1
	8132-1521	Carrier (inch)	
24	8132-1034	Carrier Adjustment Plate	2
25	0603-1016	Screw (metric)	8
	2212-1020	Screw (inch)	
27	7906-1067	Screw	8
28	8132-1076	Carrier Bearing	2
29a ⁴	NPRMXP32P	Replacement Bearing Rail (Specify stroke)	A/R
29b ⁴		add DW for Dual Carrier add BB for optional Bearing Blocks	
30	NNRMXP32P	Replacement Nut Rail (8132-1053) Specify Stroke	A/R
31	8125-1023	Screw	A/R

¹ Parts included in Repair Kits RKMXP32PSK (inch), RKMXP32PSM (metric).

² Parts included in Head Assemblies (16).

³ Part exclusive to single-end porting option.

⁴ ⚠ Bearing Blocks and/or Bearing Rail purchased before Oct. 1, 2014 are NOT compatible with current Bearing Blocks and Bearing Rails purchased after Oct. 1, 2014.

CYLINDER DISASSEMBLY INSTRUCTIONS

Begin with a clean work area. Make sure all replacement parts are available and have no visual damage or defects. The following tools and materials are recommended for proper disassembly and assembly. (Exact wrench sizes will vary depending on cylinder size.)

- Allen wrench set (std. and metric)
- Small Straight edge screwdriver
- Socket wrench & socket set
- Needle nose pliers
- RheoGel TEK664 grease
- Tin snips

For best actuator performance it is recommended that the following instructions be read and followed carefully.

1. REMOVE BAND CYLINDER FROM MACHINERY

Remove all mounting hardware and air connections, if present, from the Cylinder Heads (16) and/or Carrier (23).

2. REMOVE CARRIER FROM CYLINDER

Remove Screws (27) from Carrier (23). Slowly lift up the Carrier and remove it from the cylinder.

CAUTION: Contaminating the Bearing Block (29b) will hinder the operation of the cylinder. Do not remove the Bearing Blocks from the Rails. If the Bearing Blocks need to be replaced so will the Bearing Rail.

Remove Screws (25), Carrier Adjustment Plates (24) and Carrier Bearing (28) from the cylinder.

3. REMOVE BEARING BLOCKS AND BEARING RAIL (OPTIONAL)

The MX Bearing System is designed to provide maximum life. Should the Bearing Blocks need replacement, the Bearing Rail will need to be replaced as well. Bearing Blocks (29b) and Bearing Rail (29a) must remain together.

If the cylinder stroke requires two Bearing Rails to be mounted, the cylinder will need to be sent to the factory. It is critical that the two Rails are aligned properly. This requires special fixtures and cannot be done in the field.

To remove both the Bearing Blocks and Bearing Rail, slide each Bearing Block off one at a time and place in a clean area. Next remove Screws (31) from the Bearing Rail (29a). Lift up on the Rail and place in a clean area.

4. LOOSEN BANDS

Loosen Screw (18) from Cylinder Head (16) approx. 4 to 5 turns, but do not remove the Screw. Tap the Screw into the Head to disengage the Band Clamp (17). Repeat the process for the other Head.

5. REMOVE HEADS

Remove the four Head Screws (15) to free each Cylinder Head (16). Remove each Head by rocking it up and down until the Head is free from the Cylinder Tube. **DO NOT TWIST!** Remove the O-Ring (20) from both Heads with a small screwdriver.

6. REMOVE DUST BAND

Remove End Caps (7) from both ends of the Piston Bracket (5) by removing Screws (10). To remove the Dust Band (3), lift one end and pull the Band through the Piston Bracket. The Band is magnetically retained so some resistance will be present when removing.

7. REMOVE SEAL BAND

CAUTION: Sealing Band edges are sharp. Grasp the top and bottom of the Band when removing, not the edges.

Slide Piston Bracket (5) out of the Tube, then remove the Sealing Band (4). Keep the Sealing Band available to assist in the reassembly of the new Sealing Band. A 6-inch piece of Band is also included in the repair kit for use during reassembly.

8. DISASSEMBLE PISTON BRACKET

Remove Wipers (8) from the Piston Bracket (5). With a small straight edge screwdriver, remove the U-Cups (13) from both Pistons (6). Remove the Cushion Seals (14) from the Piston. Remove the Pistons (6) by inserting the screwdriver under the Piston side tabs until the side retaining tabs are disengaged from the Piston Bracket (5). With a small

screwdriver, remove the Band Ramps (9) by disengaging the side retaining tabs from the Piston Bracket. Keep the Piston Bracket and Pistons separated for reassembly.

CYLINDER ASSEMBLY INSTRUCTIONS

1. CLEAN AND LUBRICATE

Thoroughly clean all components, particularly the Tube Bore, Tube Slot and Bands. Thoroughly lubricate the bore of the Tube with a thin, uniform layer of RheoGel TEK664 grease.

2. ASSEMBLY OF PISTON BRACKET

With the Piston Bracket (5) in hand, install the Band Ramps (9) so the smaller ends are on the bottom. Install the Pistons (6) with the ramp facing up. Slide the Piston onto the Piston Bracket. It should snap easily into place. Install new lubricated U-Cups (13) (seal lips facing out), and Cushion Seals (14) (small end facing out). Slide new Wipers (8) into the groove on the Piston Bracket (5), flat side of Wiper out, Wiper groove on the inside (see illustration). Trim to edge of Piston Bracket (5) and flare Wiper (8) edges outward.

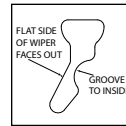

3. INSTALL INNER SEALING BAND

CAUTION: Metal edges of Sealing Band are sharp. Exercise caution to avoid injury to yourself while installing. Handle Sealing Band with care. Do not damage edges while handling.

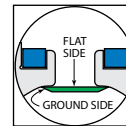

Insert Sealing Band (4) into Cylinder Tube (1) by laying the Band out along the length of the actuator and passing it sideways through slot in Tube. With flat side facing up (ground side facing down), position the Band so a Piston Bracket's length of Band extends from the Tube at one end.

4. INSTALL PISTON ASSEMBLY

Place generous amounts of grease around bore of Tube (1) on both ends and fill indentations on both sides of Piston Bracket (5) with grease. Using 6-inch length of Seal Band included with repair kit, or a short length of the old Seal Band, slightly kink the Band upwards, one inch (25mm) from the end. Insert into slot between the Band Ramp (9) and Piston (6) on the Piston Bracket (5), and stop against opposite side of the Piston. Feed the extended Sealing Band through the opposite end of the Piston Bracket (5) and up the short length of inserted Band. Once the Sealing Band is through the Piston Bracket, remove the short length of Band material and discard.

Grasp the Piston Bracket (5) while holding the Wipers (8) in place with your fingers. Flare the Wiper edges out while inserting the Piston Bracket partway into the Tube. Do not force the Piston Bracket. Place a finger over the opposite end of the Piston Bracket to keep the Wipers in place, while pushing the remainder of Piston Bracket into the Tube. If the Piston Assembly experiences resistance, use a small screw driver to press in on the ends of the Band Ramps (9) where it contacts the Tube (1). With the Piston Bracket in place, slide the length of the greased Tube until the end of the Piston just extends out the Tube. Wipe off the excess grease from the Piston end.

NOTE: If Tube and Piston Assembly were greased properly, excess grease should be present as the Piston exits end of Tube. If this is not the case, more grease will need to be added.

5. INSTALL ONE HEAD

CAUTION: Twisting the Head during installation may cut the O-Rings resulting in excessive leakage during operation.

Install new lubricated O-Rings (20) onto each Head (16). Position the Seal Band (4) leaving .775" (19.7 mm) of Band protruding from the end of the Tube. Install Head into Tube holding Screw (18) in place. Position the Seal Band (4) on the bottom side of the Band Clamp (17). Use a slight up and down rocking motion (not side-to-side or twisting) to insert the first Head into Tube. The Head should be flush with the end of the Tube after installation.

Apply RheoGel TEK664 to threads of Head Screw (15) and install into Head. Torque Screws to 70 – 80 in-lbs (8 – 9 N-m).

6. INSTALL DUST BAND

Place Dust Band (3) through the upper slot of Piston Bracket (5) and lay on top of the Cylinder Tube slot. Bend the Dust Band downward at a slight angle (see illustration), .775" (19.7mm) from the end of the Band. Position the Dust Band on top of the Band Clamp (17). Hold Screw (18) in while inserting the Dust Band into the first Head (16). Tighten Screw (18). When completed pull the other end of the Dust Band to make sure it is secured. Repeat the process if necessary. Install End Caps (7) with Screws (10) onto Piston Bracket.

7. INSTALL OTHER HEAD

Position the Dust Band (3) so the end of the Sealing Band (4) is visible. With a tin snips, trim the Sealing Band (4) leaving .775" (19.7 mm) of Band protruding from the end of the Tube. Reposition the Dust Band and trim to the same length. Repeat step 5 to install the other Head (16). Bend the Dust Band (3) downward at a slight angle .775" (19.7 mm) from the end of the Band. Position the Dust Band on top of the Band Clamp (17). Hold screw (18) in while inserting the Dust Band into the first Head (16). Tighten Screw (18).

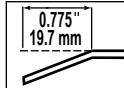

8. CHECK ASSEMBLY

Manually push the Piston Bracket (5) back and forth along the full stroke to make certain that the cylinder is properly assembled before reconnecting to the pneumatic supply. The Piston Bracket should move consistently with minimal friction along the stroke.

9. INSTALL BEARING BLOCKS AND BEARING RAIL (OPTIONAL)

If you completed Step 3 in the disassembly procedure place the new Bearing Rail (29a) on top of Nut Rail (30) with the reference mark located on the bottom of the Rail towards the Piston Bracket (5). Next start all the Screws (31) that hold the Rail, but do not tighten. Center the Bearing Rail (29a) along the length and width of the cylinder, making sure the ends of the Rail do not cover the Heads. Also, once the Rail has been centered, tighten all Screws (31). Slide on the new Bearing Blocks (29b) one at a time, with the reference mark facing you.

10. INSTALL THE CARRIER

Slide the two Bearing Blocks (29b) so they are lined up with both ends of the Piston Assembly. Place the Carrier (23) over the top of the Bearing Blocks (29b). Carefully slide the two Bearing Blocks under the Carrier (23), until the holes from the top of the Carrier and the Bearing Blocks align. Install Screws (27) into the Carrier and tighten.

Replace Carrier Adjustment Plates (24) and then install the Carrier Bearing (28) into the indent on the Adjustment Blocks. Install and tighten Screws (25) making sure Carrier is captured.

11. REMOUNT THE CYLINDER ONTO THE MACHINE

⚠ Be certain any flow controls are in place and adjusted prior to applying compressed air to the cylinder.

Options - List of Parts

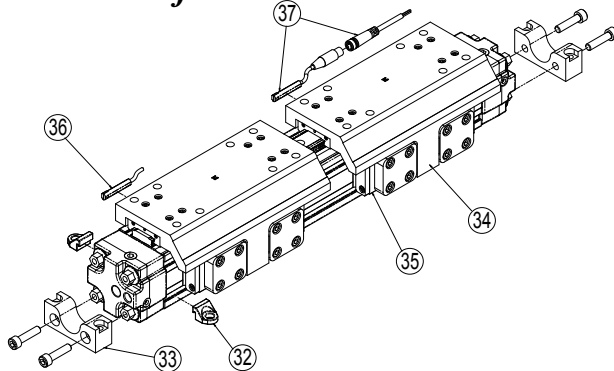

ITEM	PART NO.	DESCRIPTION
MOUNTING KITS		
32 ¹	8132-9018	Tube Clamp Mounting Kit
	8132-1050	Tube Clamp
33 ²	8132-9019	Foot Mount Kit (metric)
	8132-9519	Foot Mount Kit (inch)
	8132-1055	Foot Mount
	2225-1044	Screw (metric)
	1209-1019	Screw (inch)
DUAL CARRIER		
34	8132-9004	Dual Carrier Assy (metric)
	8132-9504	Dual Carrier Assy (inch)
35	8132-9028	Dual Carrier Piston Bracket Assy (metric)
	8132-9528	Dual Carrier Piston Bracket Assy (inch)
SWITCHES		
36	Switches without Quick-Disconnect Couplers	
	SWMXP32 RY	Reed Switch, SPST Normally Open
	SWMXP32 NY	Reed Switch, SPST Normally Closed
	SWMXP32 TY	Solid State Switch, PNP (sourcing) Normally Open
	SWMXP32 KY	Solid State Switch, NPN (sinking) Normally Open
	SWMXP32 PY	Solid State Switch, PNP (sourcing) Normally Closed
	SWMXP32 HY	Solid State Switch, NPN (sinking) Normally Closed
SWITCHES (CONT)		

ITEM	PART NO.	DESCRIPTION
37	Switches with Quick-Disconnect Couplers	
	SWMXP32 RK	Reed Switch, SPST Normally Open
	SWMXP32 NK	Reed Switch, SPST Normally Closed
	SWMXP32 TK	Solid State Switch, PNP (sourcing) Normally Open
	SWMXP32 KK	Solid State Switch, NPN (sinking) Normally Open
	SWMXP32 PK	Solid State Switch, PNP (sourcing) Normally Closed
	SWMXP32 HK	Solid State Switch, NPN (sinking) Normally Closed
NOTE: Female Connector for Quick-Disconnect is included		
SHOCK ABSORBERS		
39	8132-1027	Carrier for Shocks (metric)
	8132-1527	Carrier for Shocks (inch)
40	4912-1063	Shock Impact Bolt
41 ³	8132-9024	Adjustable Shock Mounting Kit
	8132-1084	Shock Bracket
	8132-1086	Shock Bracket Clamp
	2212-1096	Screw
42 ⁴	8132-9022	Fixed Shock Mounting Kit (metric)
	8132-9522	Fixed Shock Mounting Kit (inch)
	8132-1064	Fixed Shock Bracket
	8132-1061	Screw (metric)
	3415-1077	Screw (inch)
43	4912-1067	Light Duty Shock Absorber
	4912-1068	Heavy Duty Shock Absorber

¹ Tube Clamp Kit contains 2 tube clamps.

² Foot Mount Kit contains 1 foot mount and 2 fasteners.

³ Adjustable Shock Mounting Kit contains 1 shock bracket, 1 bracket clamp and 2 fasteners.

⁴ Fixed Shock Mounting Kit contains 1 shock bracket and 2 fasteners.

LUBRICATION AND MAINTENANCE

All Tolomatic MX Band Cylinders are prelubricated at the factory. To ensure maximum cylinder life, the following guidelines should be followed.

1. Filtration

We recommend the use of dry, filtered air in our products. "Filtered air" means a level of 10 Micron or less. "Dry" means air should be free of appreciable amounts of moisture. Regular maintenance of installed filters will generally keep excess moisture in check.

2. External Lubricators (optional)

The factory prelubrication of Tolomatic Band Cylinders will provide optimal performance without the use of external lubrication. However, external lubricators can further extend service life of pneumatic actuators if the supply is kept constant.

Oil lubricators, (mist or drop) should supply a minimum of 1 drop per 20 standard cubic feet per minute to the cylinder. As a rule of thumb, double that rate if water in the system is suspected. Demanding conditions may require more lubricant.

If lubricators are used, we recommend a non-detergent, 20cP @ 140°F 10-weight lubricant. Optimum conditions for standard cylinder operation is +32° to +150°F (+0° to 65.5°C).

NOTE: Use of external lubricators may wash away the factory installed lubrication. External lubricants must be maintained in a constant supply or the results will be a dry actuator prone to premature wear.

3. Sanitary Environments

Oil mist lubricators must dispense "Food Grade" lubricants to the air supply. Use fluids with ORAL LD50 toxicity ratings of 35 or higher such as Multitherm® PG-1 or equivalent. Demanding conditions can require a review of the application.

4. Cushion Adjustment

Adjust the Cushion Needles in the Cylinder Heads carefully to obtain optimum deceleration for your particular application. If there are questions on proper adjustment, please consult Tolomatic.

SWITCH WIRING DIAGRAMS AND LABEL COLOR CODING (CE and RoHS Compliant)

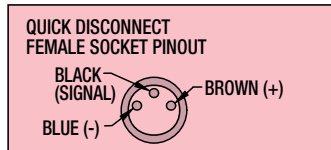
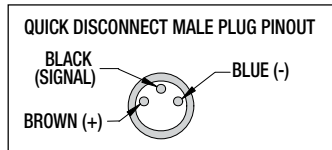
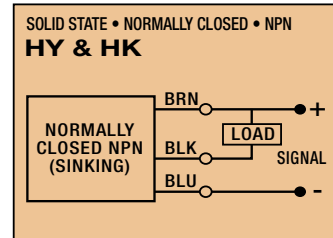
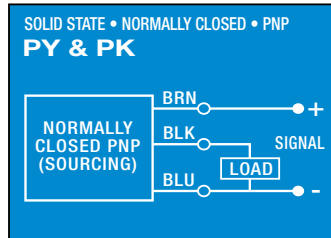
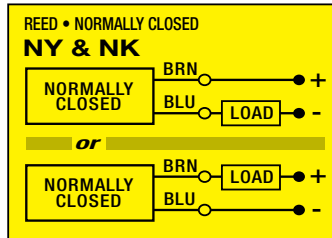
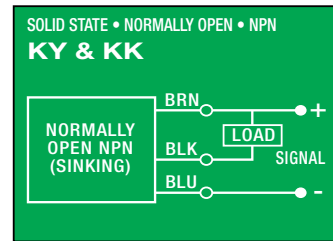
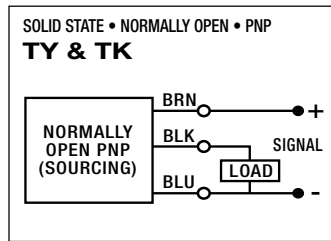
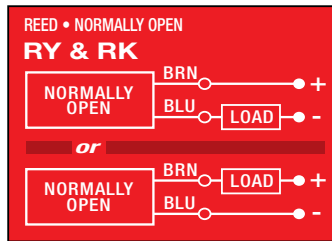

Switches for MX:

- Include retained mounting hardware
- In slot, sit below extrusion profile
- Same for all sizes and bearing styles

SWITCH INSTALLATION AND REPLACEMENT

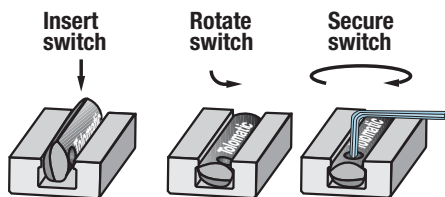

Place switch in side groove on tube at desired location with "Tolomatic" facing outward. While applying light pressure to the switch, rotate it such that the switch is halfway in the groove. Maintaining light pressure, rotate the switch in the opposite direction until the switch is fully inside the groove with "Tolomatic" visible. Re-position the switch to the exact location and lock the switch securely into place by tightening the screw on the switch.

SWITCH DETECTION POINT

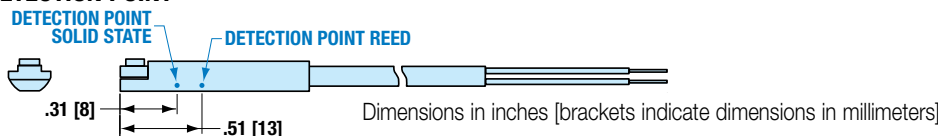

3800 County Road 116, Hamel, MN 55340
 http://www.Tolomatic.com • Email: Help@Tolomatic.com
 Phone: (763) 478-8000 • Toll Free: 1-800-328-2174

COMPANY WITH
 QUALITY SYSTEM
 CERTIFIED BY DNV
 = ISO 9001 =

Information furnished is believed to be accurate and reliable. However, Tolomatic assumes no responsibility for its use or for any errors that may appear in this document. Tolomatic reserves the right to change the design or operation of the equipment described herein and any associated motion products without notice. Information in this document is subject to change without notice.