

BCS RODLESS SCREW DRIVE ACTUATORS

ENDURANCE TECHNOLOGYSM
A Tolomatic Design Principle



CONTENTS

BCS Features	BCS_2
Critical Speed Capacities	BCS_4
Specifications	BCS_6
Support Recommendations	BCS_8
BCS10 Specifications	BCS_10
BCS10 Dimensions	BCS_12
BCS15 Specifications	BCS_14
BCS15 Dimensions	BCS_17
BCS20 Specifications	BCS_19
BCS20 Dimensions	BCS_20
Switches	BCS_22
Application Data Worksheet	BCS_24
Selection Guidelines	BCS_25
Ordering	BCS_26

BCS RODLESS SCREW DRIVE ACTUATORS

ENDURANCE TECHNOLOGYSM

Endurance Technology features are designed for maximum durability to provide extended service life.

A Tolomatic Design Principle

This rodless style actuator is designed for carrying light to moderate loads at an economical price. Based upon our BC2 pneumatic band cylinder, it utilizes a guidance system consisting of an adjustable carrier bracket with two solid bearing rods that transmit the load to the actuator body for superior load support. Built-to-order in stroke lengths up to 3 m [120 inches] with multiple screw options available.

ADJUSTABLE CARRIER BRACKET

- Allows for easy adjustment and replacement of the load bearings throughout the life of the actuator
- Allows customizing the bearing tension and free play of the carrier to meet the applications requirements



FORMED END CAP WIPERS

Prevent contaminants from entering the sealing band area to protect internal components

LOAD-BEARING CARRIER DESIGN

- Engineered resin bearings provide guidance, low friction loss and long life
- Load and moments are transmitted directly to the actuator body



SCREW SUPPORT BEARINGS

High thrust bearing assembly design isolates the motor from axial forces

MULTIPLE SCREW TECHNOLOGIES

YOU CAN CHOOSE:

- Solid nuts of engineered resins offer quiet performance at the lowest cost; anti-backlash available
- Ball nuts offer positioning accuracy and repeatability with longer life; low-backlash available



TOLOMATIC...LINEAR SOLUTIONS MADE EASY

EXTERNAL BUMPERS

Bumpers protect the screw and nut assembly from damage at end of stroke

STAINLESS STEEL SEALING BAND

- Prevents contaminants from entering the screw and nut area for prolonged life
- Fatigue resistant stainless steel bands are specifically made to offer long life and will not elongate

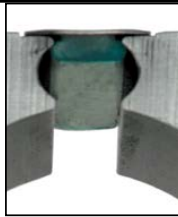

LIGHTWEIGHT ALUMINUM DESIGN

- Black anodized extrusion design is optimized for rigidity and strength
- External switch channels on both sides allow easy placement and adjustment of position indicating switches

MOTOR ORIENTATION

YOU CAN CHOOSE:

- Inline option directly couples the driving shafts and is a one-piece housing construction for optimum alignment and support of the motor
- Reverse-parallel option minimizes the overall length and offers a 1:1 or 2:1 belt ratio

YOUR MOTOR HERE

YOU CAN CHOOSE:

- Motor or gearbox supplied and installed by Tolomatic
- Specify the device to be installed and actuator ships with proper mounting hardware
- Specify and ship your device to Tolomatic for factory installation
LMI (inline) motor mount only

OPTIONS

CARRIER OPTIONS

- AUXILIARY CARRIER** doubles the load capacity and increases bending moments capacity significantly
- FLOATING MOUNT** compensates for non-parallelism between the actuator and an external support or guidance system

MOUNTING OPTIONS

- SURFACE MOUNT** tapped holes are provided on the underside of the actuator heads, as a standard feature, for direct mounting
- TUBE SUPPORTS** provide intermediate support of the actuator body throughout long stroke lengths
- METRIC OPTION**
Provides metric tapped holes for mounting of load to carrier and of actuator to mating surfaces

SWITCHES

- Styles include: reed, hall-effect or triac. Select either 5 m potted cable with flying leads or 150 mm to quick-disconnect coupler with mating 5 m cable.

BCS Rodless Screw Drive Actuators



sizeit.tolomatic.com
for fast, accurate
actuator selection

ACME SCREW/NUT COMBINATIONS

ACME SCREW CRITICAL SPEED CAPACITIES

CRITICAL SPEED WITH METRIC ACME SCREW

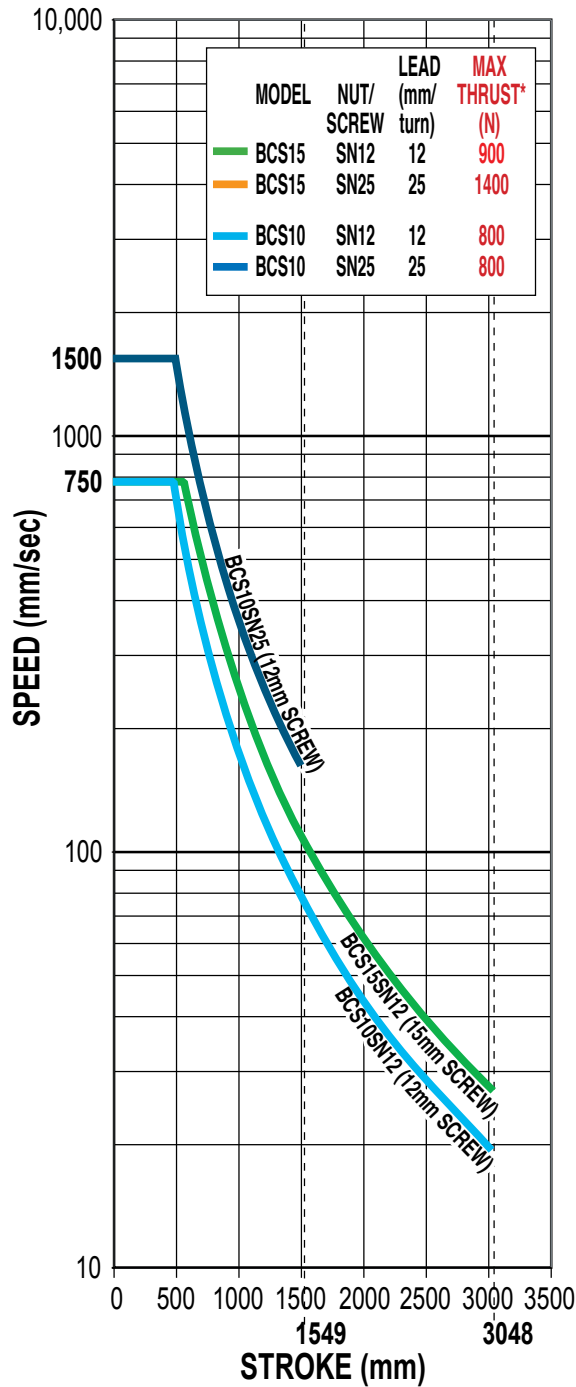

CRITICAL SPEED WITH US CONVENTIONAL ACME SCREW

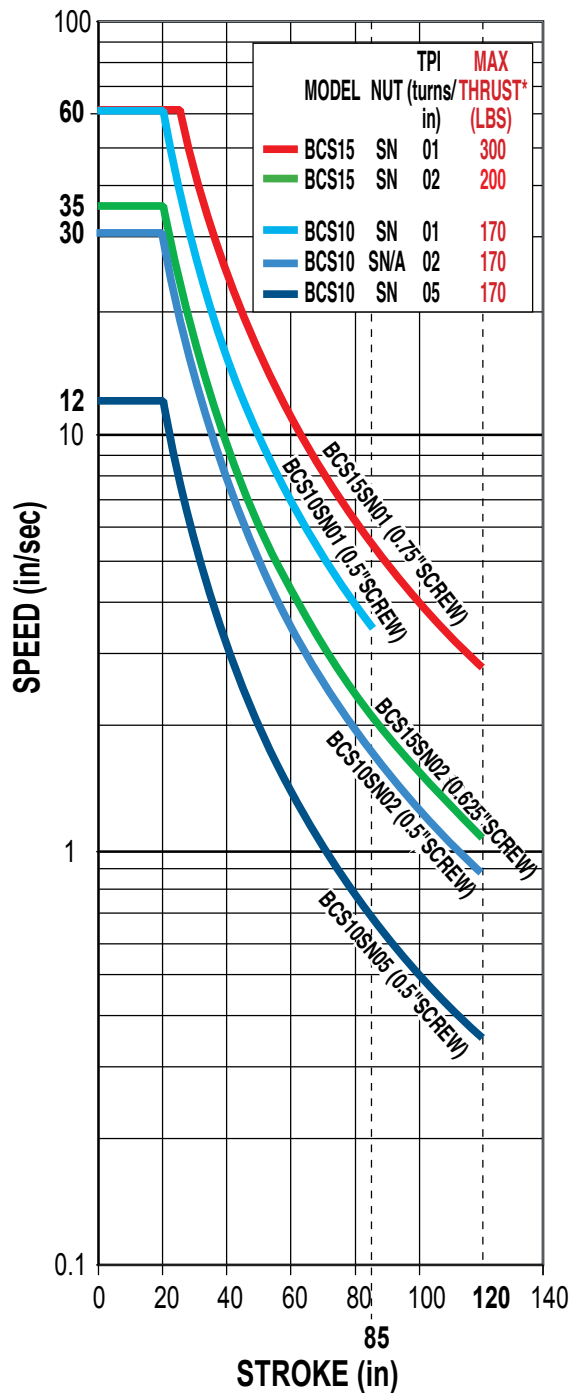

* Maximum thrust is the maximum continuous dynamic thrust subject to Thrust x Velocity limitation.

Dotted lines represent maximum stroke for screw selections.

For Screw PV limits, refer to the individual charts located in the technical section for each actuator body size.

BCS Rodless Screw Drive Actuators



sizeit.tolomatic.com
for fast, accurate
actuator selection

BALL SCREW/NUT COMBINATIONS

BALL SCREW CRITICAL SPEED CAPACITIES

CRITICAL SPEED WITH METRIC BALL SCREW

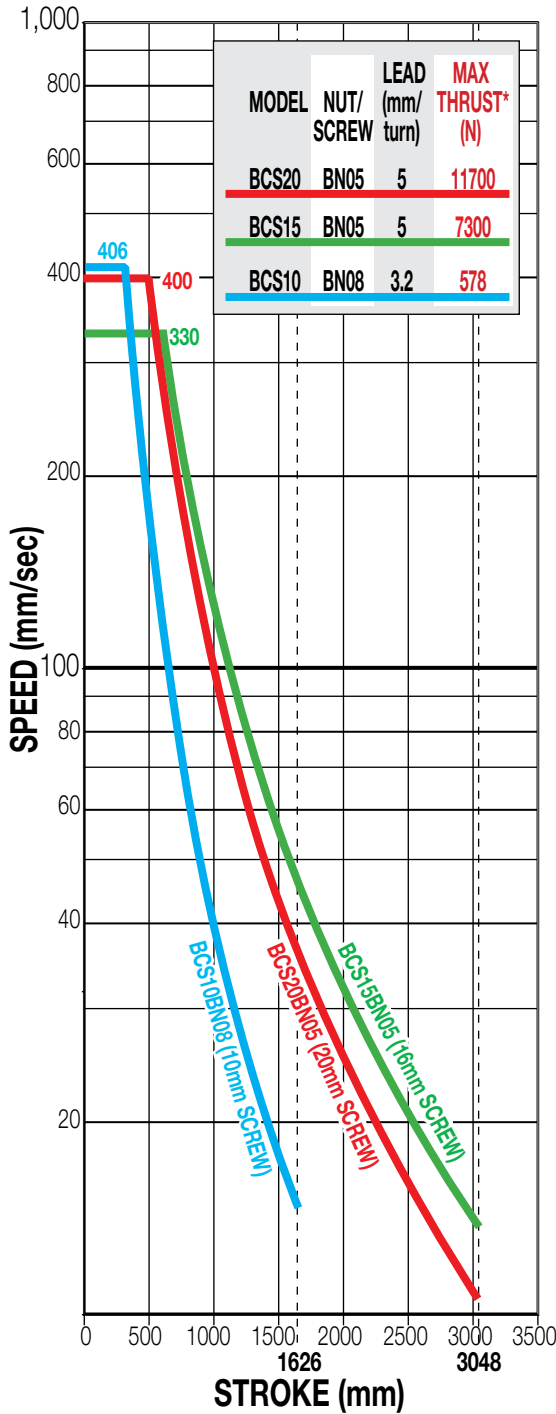

CRITICAL SPEED WITH US CONVENTIONAL BALL SCREW

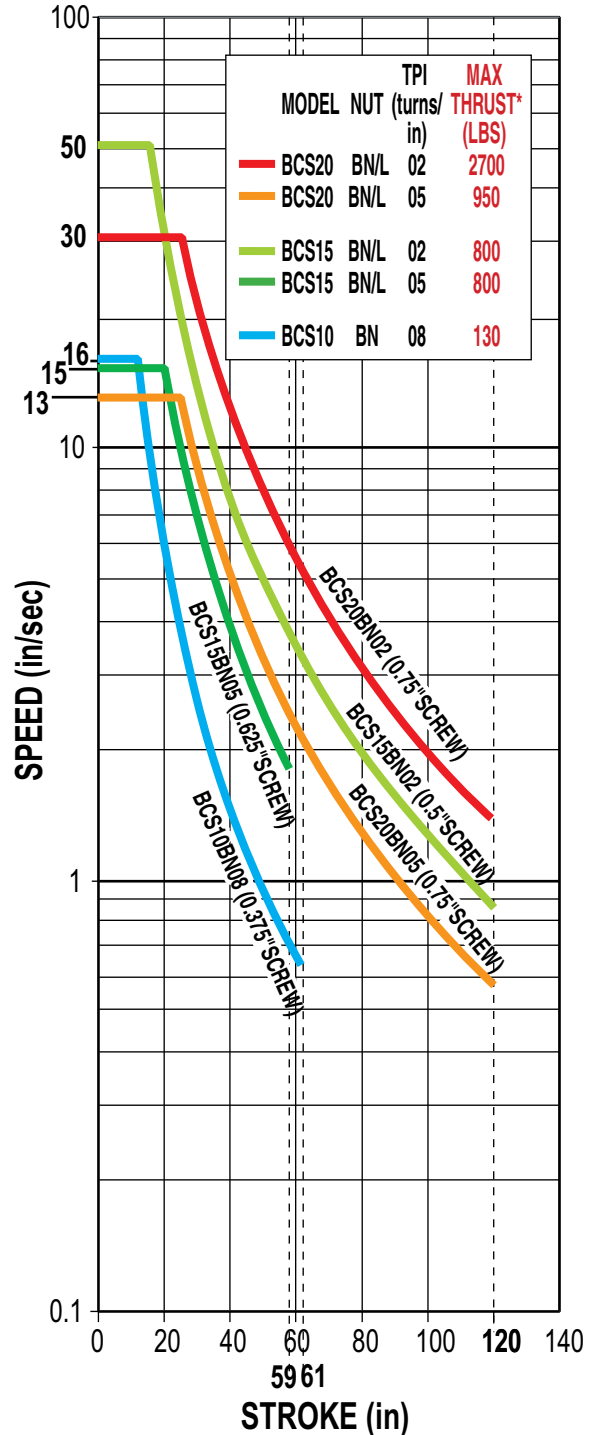

* Maximum thrust reflects 90% reliability for 25 million linear millimeters of travel.

Dotted lines represent maximum stroke for screw selections.

Refer to the technical section for each actuator body size for details on life calculations for individual screws.

BCS Rodless Screw Drive Actuators



sizeit.tolomatic.com
for fast, accurate
actuator selection

BALL SCREW SPECIFICATIONS

BALL SCREW LIFE CALCULATION

LIFE CAPACITIES WITH METRIC BALL SCREW

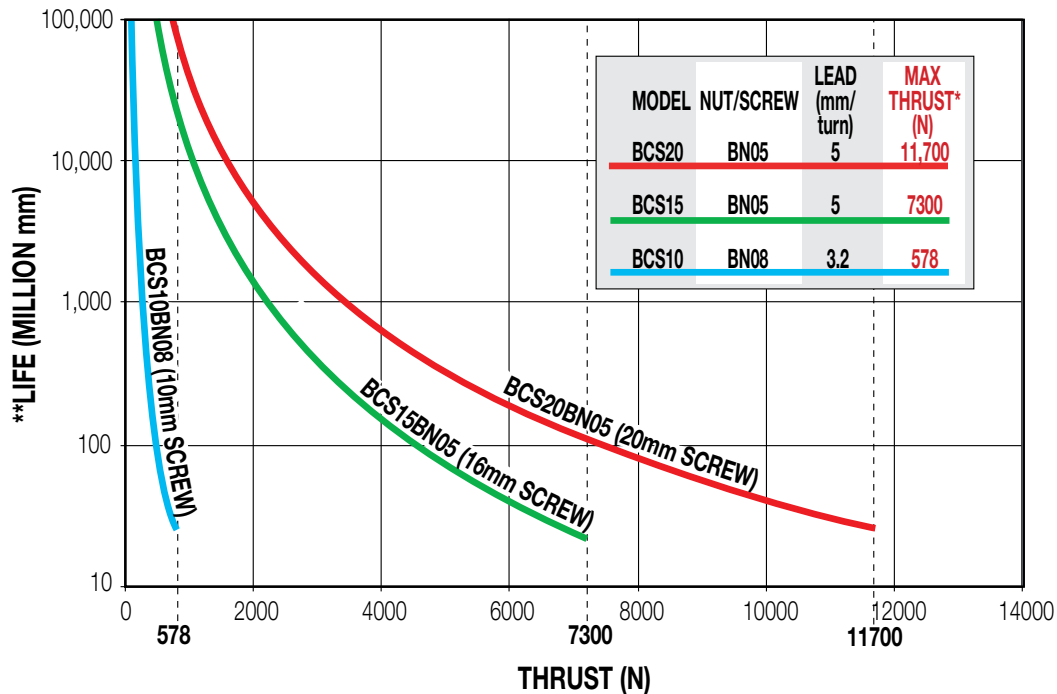

LIFE CAPACITIES WITH US CONVENTIONAL BALL SCREW

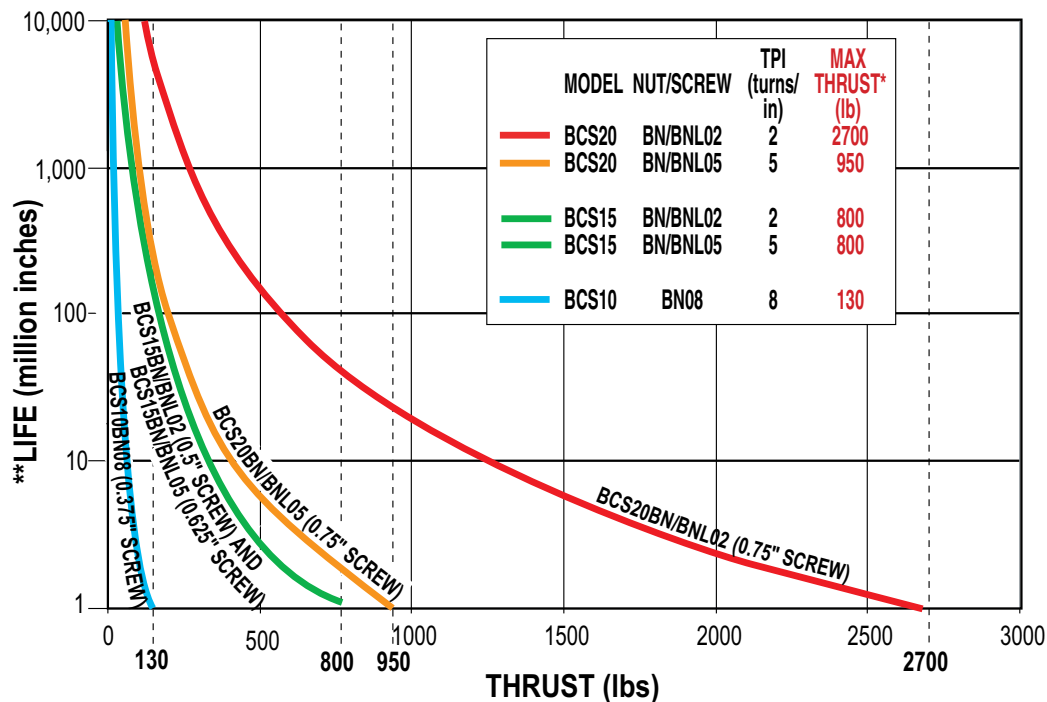

* Maximum thrust reflects 90% reliability for 25 million linear millimeters of travel.

Dotted lines represent maximum thrust for screw selections.

**Life indicates theoretical maximum life of screw only, under ideal conditions and does not indicate expected life of actuator.

BCS Rodless Screw Drive Actuators

SPECIFICATIONS



sizeit.tolomatic.com
for fast, accurate
actuator selection

SPECIFICATIONS RELATED TO ACTUATOR SIZE AND SCREW SELECTION

METRIC LEAD SCREW

ACTUATOR SERIES	SCREW DIA. (mm)	SCREW TYPE	LEAD (mm/turn)	LEAD ACCURACY (mm/300)	BACKLASH (mm)	MAXIMUM THRUST* (N)	MAXIMUM STROKE (mm)	INERTIA (kg-m ² x 10 ⁻⁶)			BREAKAWAY TORQUE (N-m)
								BASE ACTUATOR		PER/mm OF STROKE	
								In Line	Rev. Parallel		
BCS10	10	BN	3.2	0.13	0.38	578	1549	31.94	37.50	3.472	0.11
	10	BNL	3.2	0.13	0.05	578	1549	31.94	67.50	3.472	0.11
	12	SN	12	0.13	0.18	800	3048	4.53	5.18	0.410	0.20
	12	SN	25	0.13	0.18	800	1626	8.34	8.98	0.410	0.28
BCS15	15	SN	12	0.13	0.18	900	3048	13.22	14.83	0.966	0.27
	16	BN	5	0.13	0.38	7300	1499	13.69	15.77	1.258	0.16
	16	BNL	5	0.13	0.05	7300	1499	13.69	15.77	1.258	0.16
	19	SN	25	0.13	0.18	1400	3048	39.98	44.17	2.517	0.32
BCS20	20	BN	5	0.13	0.38	11700	3048	38.61	43.32	3.102	0.25
	20	BNL	5	0.13	0.05	11700	3048	38.61	43.32	3.102	0.25

US CONVENTIONAL LEAD SCREWS

ACTUATOR SERIES	SCREW DIA. (in)	SCREW TYPE	TPI (turns/in)	LEAD ACCURACY (in/ft)	BACKLASH (in)	MAXIMUM THRUST* (lb)	MAXIMUM STROKE (in)	INERTIA (lb-in ²)			BREAKAWAY TORQUE (lb-in)
								BASE ACTUATOR		PER/in OF STROKE	
								In Line	Rev. Parallel		
BCS10	0.375	BN	08	0.004	0.015	130	61	0.0046	0.0054	0.0005	1.000
	0.375	BNL	08	0.004	0.002	130	61	0.0046	0.0054	0.0005	1.000
	0.500	SN	01	0.006	0.007	170	85	0.0321	0.0348	0.0017	1.857
	0.500	SN	02	0.005	0.007	170	120	0.0190	0.0217	0.0017	1.563
	0.500	SNA	02	0.005	0.003	170	120	0.0190	0.0217	0.0017	1.563
	0.500	SN	05	0.006	0.007	170	120	0.0153	0.0180	0.0017	1.125
BCS15	0.500	BN	02	0.003	0.015	800	59	0.0299	0.0327	0.0017	1.375
	0.500	BNL	02	0.003	0.002	800	59	0.0299	0.0327	0.0017	1.375
	0.625	BN	05	0.003	0.015	800	59	0.0455	0.0524	0.0042	1.188
	0.625	BNL	05	0.003	0.002	800	59	0.0455	0.0524	0.0042	1.188
	0.625	SN	02	0.005	0.007	200	120	0.0558	0.0627	0.0042	1.563
	0.750	SN	01	0.005	0.007	300	120	0.1391	0.1536	0.0087	2.188
BCS20	0.750	BN	02	0.004	0.015	2700	120	0.1241	0.1374	0.0087	1.750
	0.750	BNL	02	0.004	0.002	2700	120	0.1241	0.1374	0.0087	1.750
	0.750	BN	05	0.003	0.015	950	120	0.1091	0.1224	0.0087	1.563
	0.750	BNL	05	0.003	0.002	950	120	0.1091	0.1224	0.0087	1.563

SCREW CODE	DESCRIPTION
SN	Solid Nut
SNA	Anti-backlash Solid Nut
BN	Ball Nut
BNL	Low-Backlash Ball Nut



Contact Tolomatic for higher accuracy and lower backlash options.

* For Acme screws, maximum thrust is the maximum continuous dynamic thrust subject to Thrust x Velocity limitation.

For ball screws, maximum thrust reflects 90% reliability for 25 million linear millimeters of travel.

BCS Rodless Screw Drive Actuators

SPECIFICATIONS



sizeit.tolomatic.com
for fast, accurate
actuator selection

GENERAL ACTUATOR SPECIFICATIONS

METRIC ACTUATORS					
ACTUATOR SERIES	CARRIER WEIGHT (kg)	BASE WEIGHT (kg) (Including Carrier)	WEIGHT PER/IN OF STROKE (g)	TEMPERATURE RANGE (C°)	IP RATING**
BCS10	0.31	1.32	3.1	4 - 54	44
BCS15	0.88	2.90	7.0	4 - 54	44
BCS20	1.27	6.62	11.9	4 - 54	44

US CONVENTIONAL ACTUATORS					
ACTUATOR SERIES	CARRIER WEIGHT (lb)	BASE WEIGHT (lb) (Including Carrier)	WEIGHT PER/IN OF STROKE (lb)	TEMPERATURE RANGE (F°)	IP RATING**
BCS10	0.69	2.91	0.176	40 - 130	44
BCS15	1.94	6.61	0.392	40 - 130	44
BCS20	2.81	14.59	0.666	40 - 130	44



- * Heat generated by the motor and drive should be taken into consideration as well as linear velocity and work cycle time. For applications that require operation outside of the recommended temperature range, contact Tolomatic.
- ** Protected against ingress of solid particles greater than 1mm (.039 in) and splashing water

LARGE FRAME MOTORS AND SMALLER SIZE ACTUATORS: Cantilevered motors need to be supported, if subjected to continuous rapid reversing duty and/or under dynamic conditions.

BCS CARRIER BRACKET BOLT ADJUSTMENT (ALL SIZES)



BCS carrier bracket adjustment bolts should be adjusted to suit each individual application, depending on the degree of rigidity required. A good starting point is to tighten the nut on the bolt until there is no lateral movement of the bolt. Then,

equally tighten each nut on the carrier bolt while moving the carrier by hand along the length of the stroke. When all lateral play in the carrier is eliminated and free movement along the length of the stroke is maintained, your carrier bracket is adjusted properly. Some applications may require fine tuning of this adjustment to gain more lateral play or a higher degree of rigidity. In demanding applications, carrier adjustments should be done periodically.



*** CAUTION:**
Over-tightening increases drive torque of motor and drive.

FRICTION FORCE

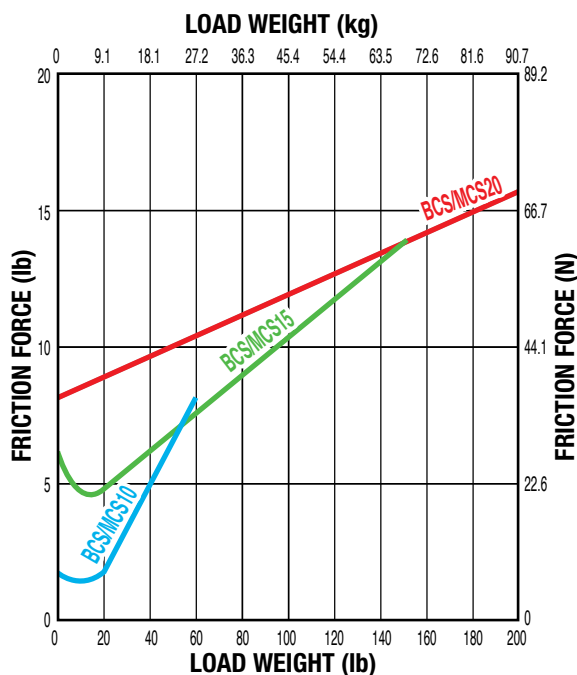

SUPPORT RECOMMENDATIONS

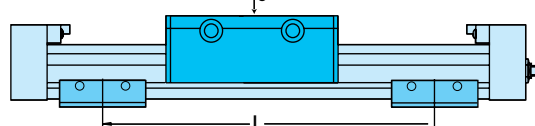
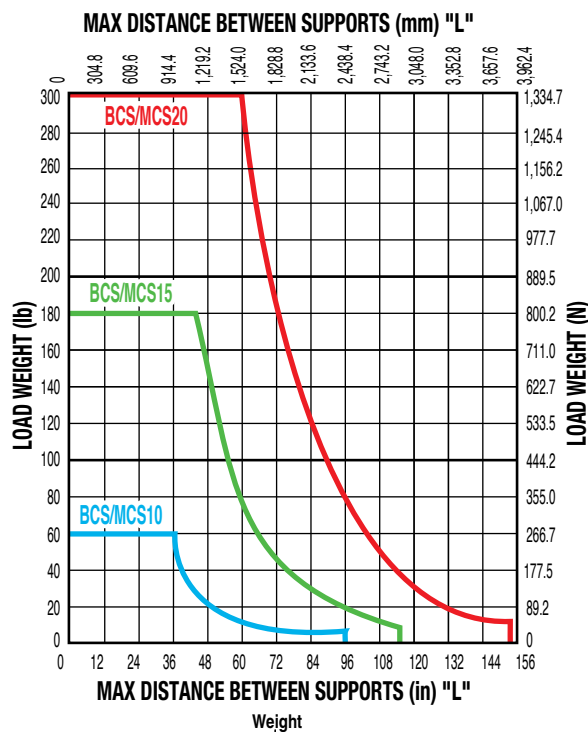

BCS Rodless Screw Drive Actuators

SPECIFICATIONS



sizeit.tolomatic.com
for fast, accurate
actuator selection

DYNAMIC BENDING MOMENTS AND LOADS

STANDARD CARRIER	MAXIMUM BENDING MOMENTS AND LOADS	METRIC			US CONVENTIONAL			
		BCS10	BCS15	BCS20	BCS10	BCS15	BCS20	
	Mx Moment (Roll)	(N·m : lb-in)	6.2	31.1	33.9	55	275	300
	My Moment (Pitch)	(N·m : lb-in)	11.3	56.5	124.3	100	500	1100
	Mz Moment (Yaw)	(N·m : lb-in)	3.4	22.6	36.7	30	200	325
	Fz Moment (Lateral)	(N : lb)	267	801	1335	60	180	300
AUXILIARY CARRIER: Increases rigidity, load-carrying capacity and moments			BCS10	BCS15	BCS20	BCS10	BCS15	BCS20
	Mx Moment (Roll)	*(N·m : lb-in)	12.4	62.1	67.8	110	550	600
	My Moment (Pitch)	*(N·m : lb-in)	32.4	164.1	274.6	287	1453	2430
	Mz Moment (Yaw)	*(N·m : lb-in)	32.4	164.1	274.6	287	1453	2430
	Fz Moment (Lateral)	(N : lb)	534	1602	2670	120	360	600
	Minimum Dimension 'D'	(mm : in)	129.5	165.0	206.0	5.10	6.50	8.10



Please see **BCS Carrier Bracket Bolt Adjustment** on page **BCS_6**



Breakaway torque will increase when using the Auxiliary carrier option. When ordering, determine your working stroke and enter this value into the configuration string. Overall actuator length will automatically be calculated.

*Loads shown in table are at minimum "D" dimension, for ratings with longer "D" dimension see graph below.

AUXILIARY CARRIER: BENDING MOMENT AT 'D' DISTANCE

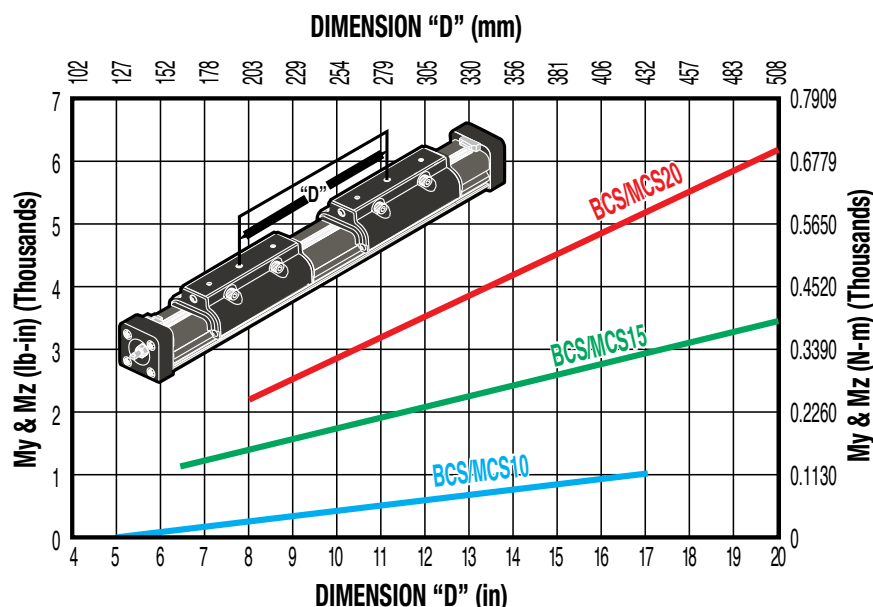

Rates shown on charts were calculated with these assumptions:

- 1.) Coupling between carriers is rigid.
- 2.) Load is equally distributed between carriers.

3.) Coupling device applies no misalignment loads to carriers.

* Customer must specify Dimension "D" (Distance between carrier center lines) in configuration string.



BCS10 Rodless Screw Drive Actuator

ACME SCREW SPECIFICATIONS

BCS10 ACME SCREW CRITICAL SPEED AND PV LIMITS

CRITICAL SPEED WITH 12mm METRIC ACME SCREW

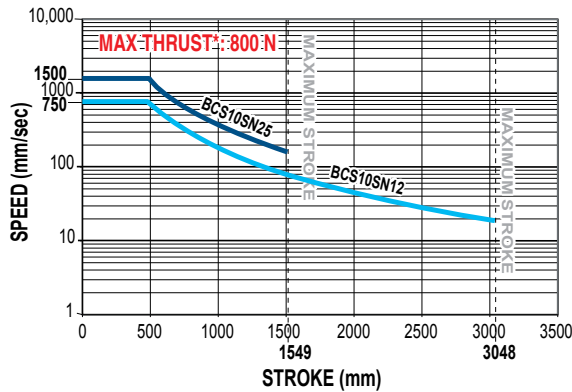

CRITICAL SPEED WITH 1/2" US CONVENTIONAL ACME SCREW

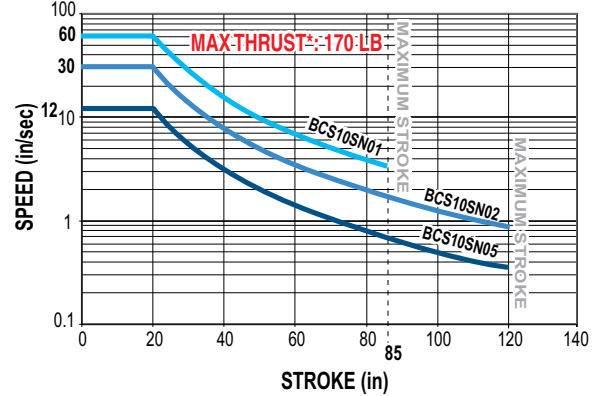

PV LIMITS: 12mm ACME METRIC SCREW w/25mm LEAD

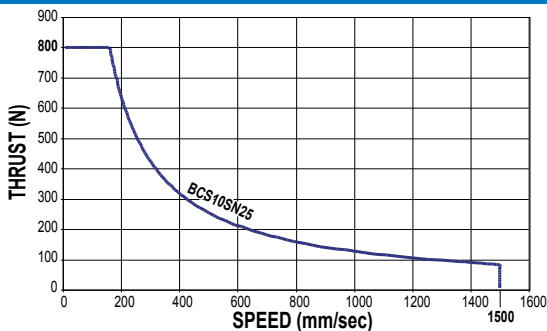

PV LIMITS: 1/2" 1 TPI US CONVENTIONAL ACME SCREW

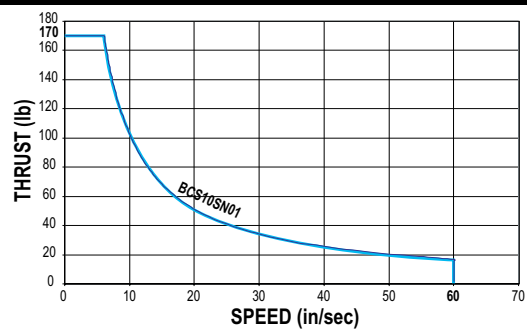

PV LIMITS: 12mm ACME METRIC SCREW w/12mm LEAD

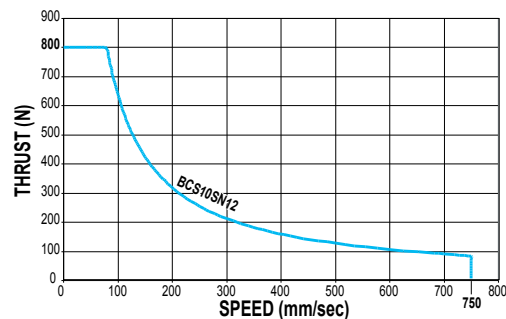

PV LIMITS: 1/2" 2 TPI US CONVENTIONAL ACME SCREW

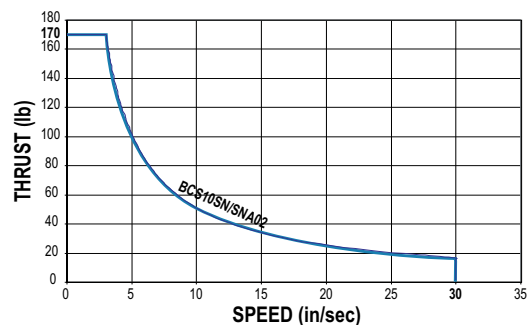

SN = Solid Nut

SNA = Solid Anti-backlash Nut

*** Maximum thrust is the maximum continuous dynamic thrust subject to Thrust x Velocity limitation.**

PV LIMITS: Any material which carries a sliding load is limited by heat buildup. The factors that affect heat generation rate in an application are the pressure on the nut in pounds per square inch and the surface velocity in feet per minute. The product of these factors provides a measure of the severity of an application.

$$\left(\frac{P}{(\text{Max. Thrust Rating})} \right) \times \left(\frac{V}{(\text{Max. Speed Rating})} \right) \leq 0.1$$

PV LIMITS: 1/2" 5 TPI US CONVENTIONAL ACME SCREW

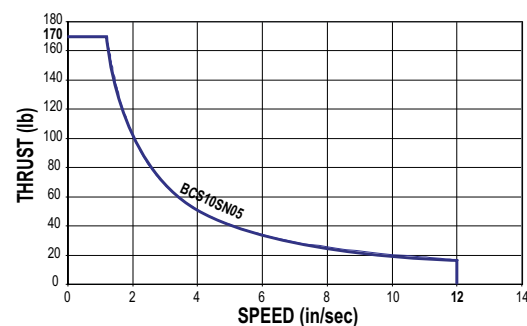

BCS10 Rodless Screw Drive Actuator



BALL SCREW SPECIFICATIONS

BCS10 BALL SCREW SPECIFICATIONS

CRITICAL SPEED WITH 10mm METRIC BALL SCREW

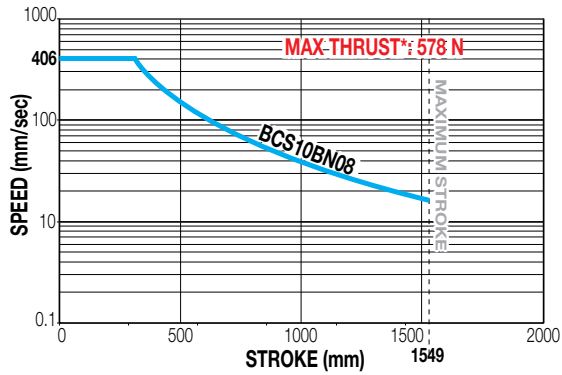

CRITICAL SPEED WITH 3/8" US CONVENTIONAL BALL SCREW

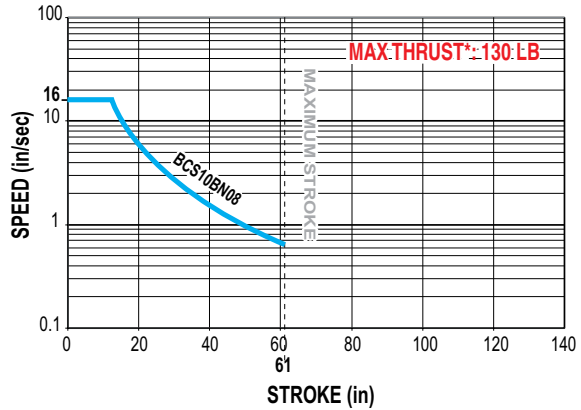

LIFE CALCULATION: 10mm METRIC BALL SCREW w/3.2mm LEAD

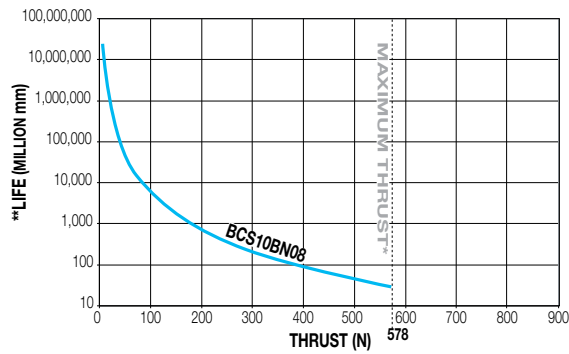

LIFE CALCULATION: 3/8" 8TPI US CONVENTIONAL BALL SCREW

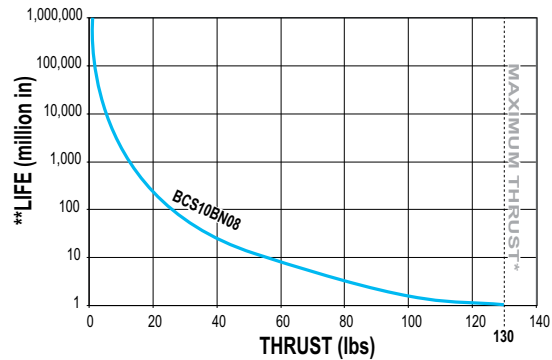

BN = Ball Nut



* Maximum thrust reflects 90% reliability for 25 million linear millimeters of travel.

**Life indicates theoretical maximum life of screw only, under ideal conditions and does not indicate expected life of actuator.

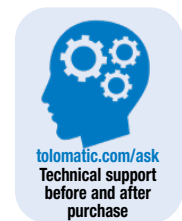

BCS10 Rodless Screw Drive Actuator

tolomatic.com/CAD Download 3D CAD
Always use CAD solid model to determine critical dimensions



DIMENSIONS

BCS10 ACTUATOR AND OPTIONS

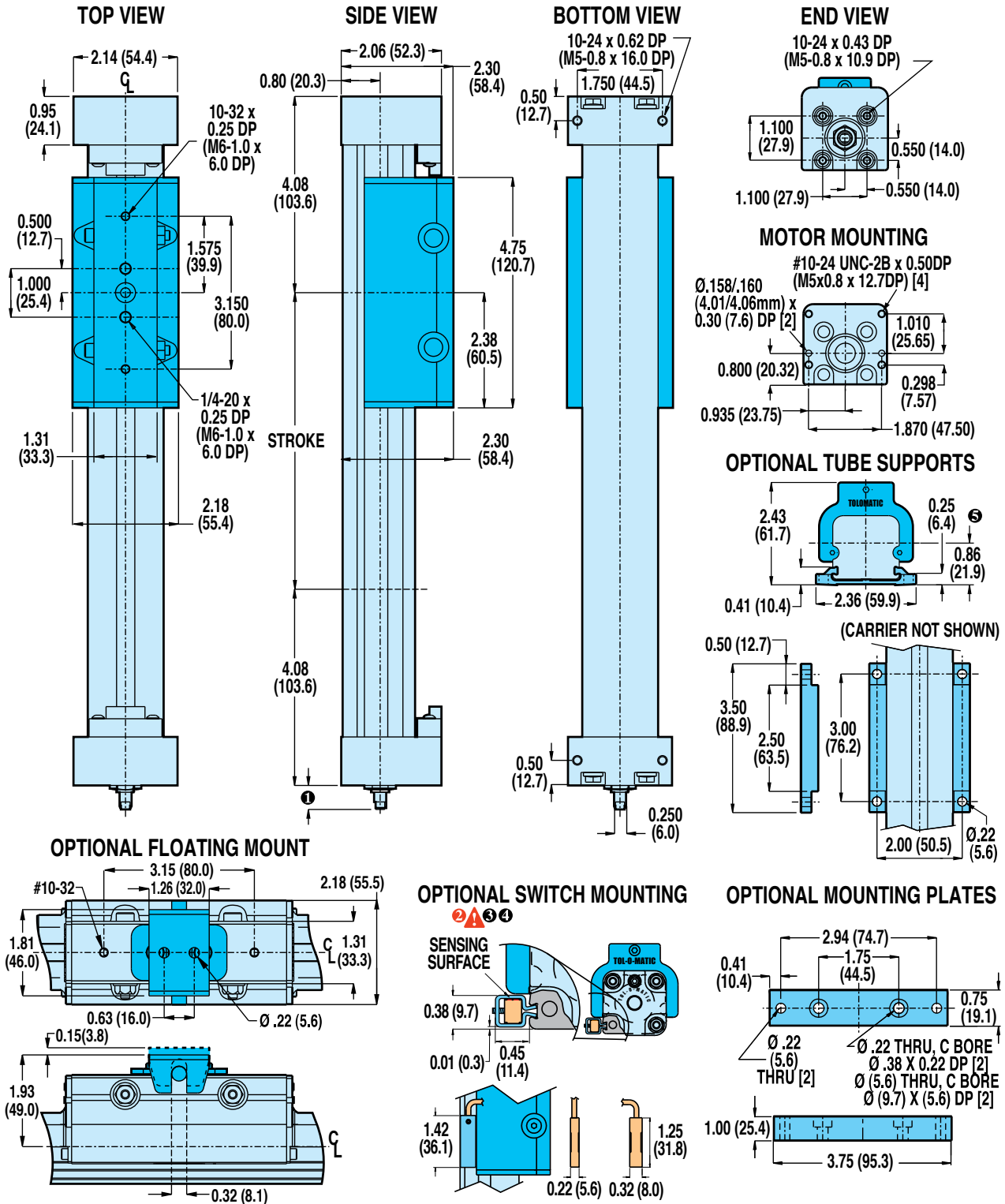

1 SHAFT LENGTH

In-line mounting	0.53 (13.5)
Extended shaft for RP & 23-frame motor	1.89 (48.0)
Extended shaft for RP & 34-frame motor	2.10 (53.3)
Extended shaft for purchases prior to 6/24/02	1.53 (38.9)

2 CAUTION: DO NOT OVERTIGHTEN SWITCH HARDWARE WHEN INSTALLING

3 NOTE: The scored face of the switch indicates the sensing surface and must face toward the magnet

4 NOTE: Some actuators require switch mounting on a specific side of the actuator. Call Tolomatic 1-800-328-2174 for details

5 NOTE: Optional tube supports or mounting plates may not always provide enough clearance between their mounting surfaces and in-line or reverse parallel motor mounting hardware.

Unless otherwise noted, all dimensions shown are in inches (Dimensions in parenthesis are in millimeters)

BCS10 Rodless Screw Drive Actuator

tolomatic.com/CAD Download 3D CAD
Always use CAD solid model to determine critical dimensions



DIMENSIONS

BCS10: IN-LINE MOUNT FOR MOTORS OR GEARHEADS

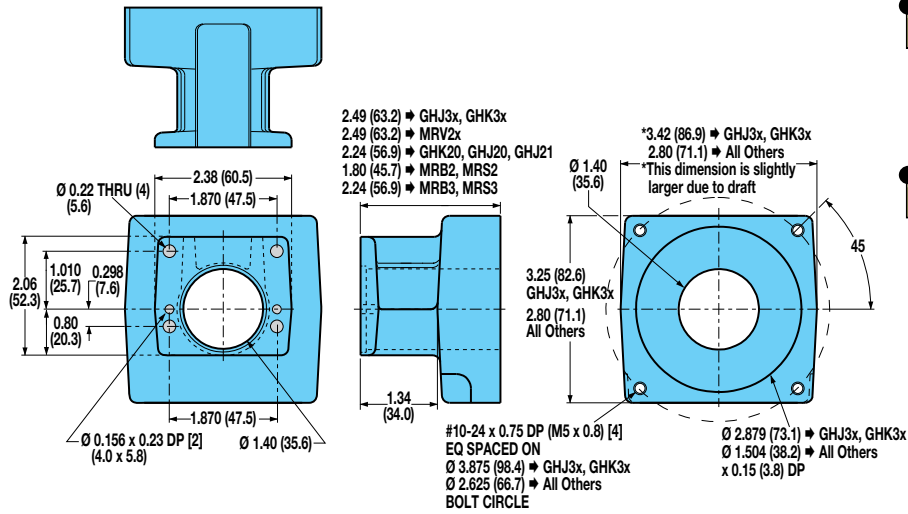

For gearhead dimensions and specifications, refer to literature #3600-4161

NOTE: MRB & MRV motors are discontinued contact Tolomatic for information on YMH (Your Motor Here)

BCS10: REVERSE PARALLEL MOUNTING

BOTTOM MOUNT

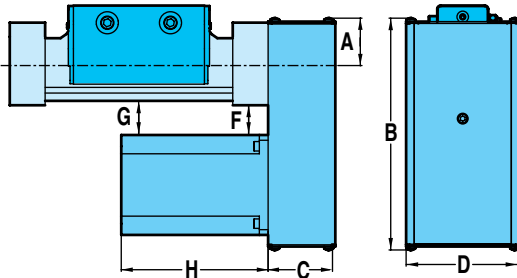

SIDE MOUNT (Right Shown)

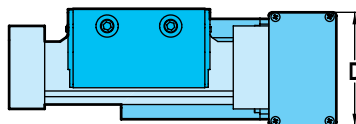
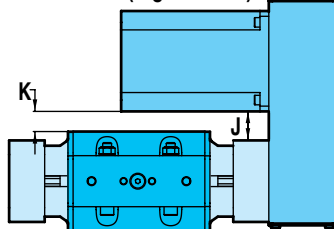

TOP MOUNT

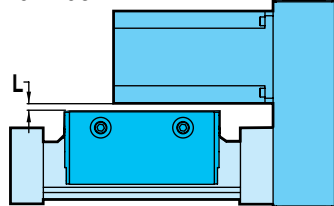

SPECIFICATIONS

NEMA 23 Frame	WEIGHT OF REDUCTION DRIVE		REDUCTION INERTIA AT MOTOR SHAFT	
	1:1	2:1	1:1	2:1
	kg	kg	kg-cm ²	kg-cm ²
	0.9344	0.9344	0.2043	0.2767

NEMA 23 Frame	WEIGHT OF REDUCTION DRIVE		REDUCTION INERTIA AT MOTOR SHAFT	
	1:1	2:1	1:1	2:1
	lbs	lbs	lb-in ²	lb-in ²
	2.06	2.06	0.070	0.095

REDUCTION EFFICIENCY: 0.95

DIMENSIONS

NEMA 23 Frame	A	B	C	D	F	G	*H	J	K	L
	mm	mm	mm	mm	mm	mm	mm	mm	mm	mm
	Size	21	22	23	24	21	22	23	24	
	36.6	176.7	54.0	82.6	45.9	46.5	120.7	39.1	46.5	28.2
							146.1			
							171.5			
							196.9			

NEMA 23 Frame	A	B	C	D	F	G	*H	J	K	L
	in.	in.	in.	in.	in.	in.	in.	in.	in.	in.
	Size	21	22	23	24	21	22	23	24	
	1.44	6.96	2.13	3.25	1.81	1.83	4.75	1.54	1.83	1.11
							5.75			
							6.75			
							7.75			

*H: Typical Motor Length



BCS15 Rodless Screw Drive Actuator

ACME SCREW SPECIFICATIONS

BCS15 US CONVENTIONAL ACME SCREW SPECIFICATIONS

CRITICAL SPEED WITH 5/8" US CONVENTIONAL ACME SCREW

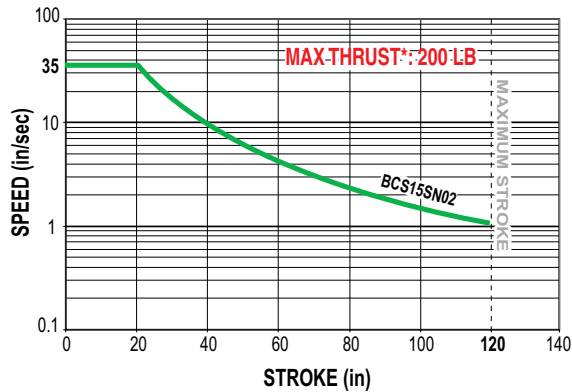

CRITICAL SPEED WITH 3/4" US CONVENTIONAL ACME SCREW

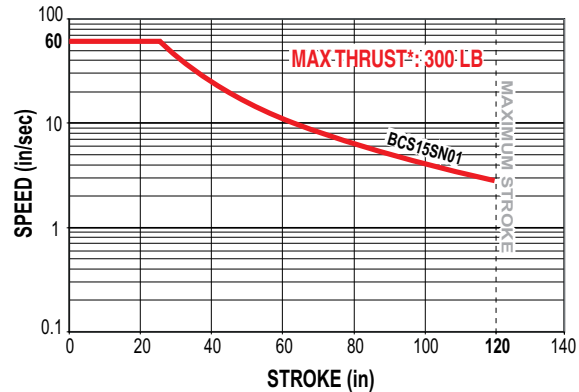

PV LIMITS: 5/8" 2TPI US CONVENTIONAL ACME SCREW

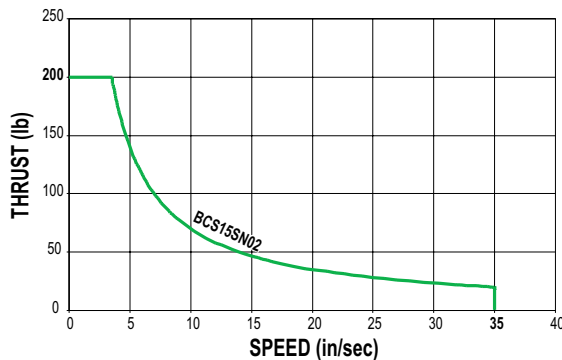

PV LIMITS: 3/4" 1TPI US CONVENTIONAL ACME SCREW

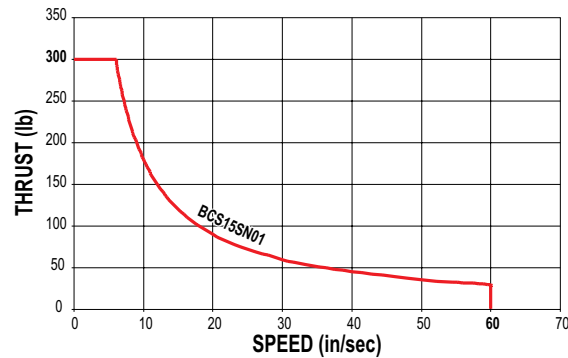

SN = Solid Nut

SNA = Solid Anti-backlash Nut



* Maximum thrust is the maximum continuous dynamic thrust subject to Thrust x Velocity limitation.

PV LIMITS: Any material which carries a sliding load is limited by heat buildup. The factors that affect heat generation rate in an application are the pressure on the nut in pounds per square inch and the surface velocity in feet per minute. The product of these factors provides a measure of the severity of an application.

$$\frac{P}{(\text{Max. Thrust Rating})} \times \frac{V}{(\text{Max. Speed Rating})} \leq 0.1$$

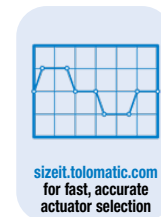

BCS15 Rodless Screw Drive Actuator



sizeit.tolomatic.com
for fast, accurate
actuator selection

ACME SCREW SPECIFICATIONS

BCS15 METRIC ACME SCREW SPECIFICATIONS

CRITICAL SPEED WITH 15mm METRIC ACME SCREW

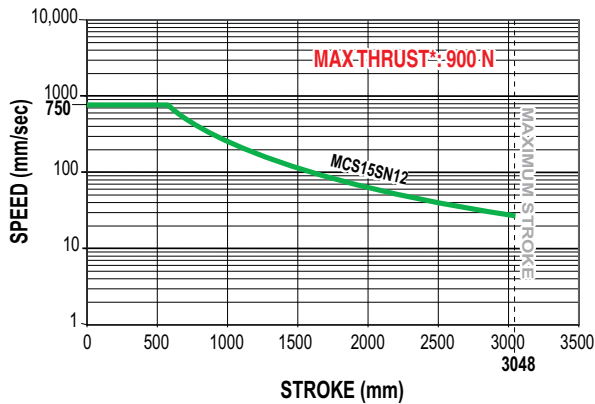

CRITICAL SPEED WITH 19mm METRIC ACME SCREW

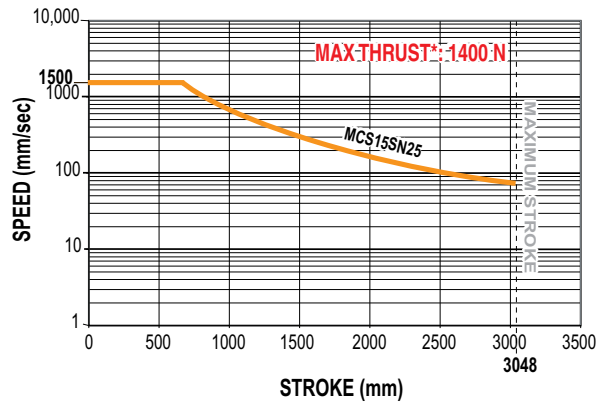

PV LIMITS: 15mm METRIC ACME SCREW w/12mm LEAD

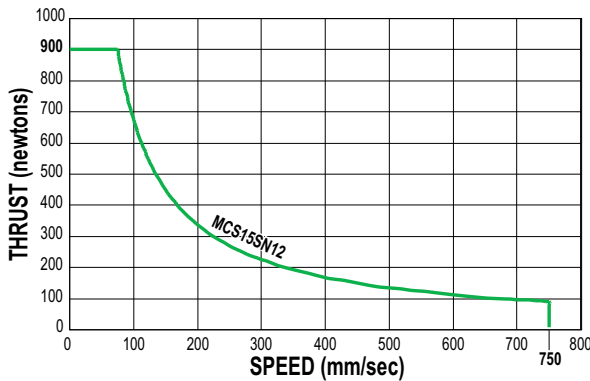

PV LIMITS: 19mm METRIC ACME SCREW w/25mm LEAD

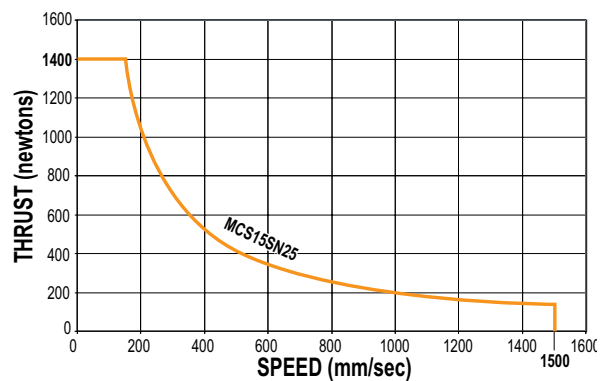

SN = Solid Nut



* Maximum thrust is the maximum continuous dynamic thrust subject to Thrust x Velocity limitation.

PV LIMITS: Any material which carries a sliding load is limited by heat buildup. The factors that affect heat generation rate in an application are the pressure on the nut in pounds per square inch and the surface velocity in feet per minute. The product of these factors provides a measure of the severity of an application.

$$\frac{P}{\left(\begin{array}{c} \text{Thrust} \\ \text{(Max. Thrust Rating)} \end{array} \right)} \times \frac{V}{\left(\begin{array}{c} \text{Speed} \\ \text{(Max. Speed Rating)} \end{array} \right)} \leq 0.1$$

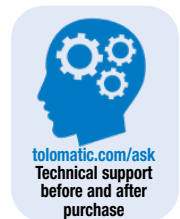

BCS15 Rodless Screw Drive Actuator



sizeit.tolomatic.com
for fast, accurate
actuator selection

BALL SCREW SPECIFICATIONS

BCS15 BALL SCREW SPECIFICATIONS

CRITICAL SPEED WITH 16mm METRIC BALL SCREW

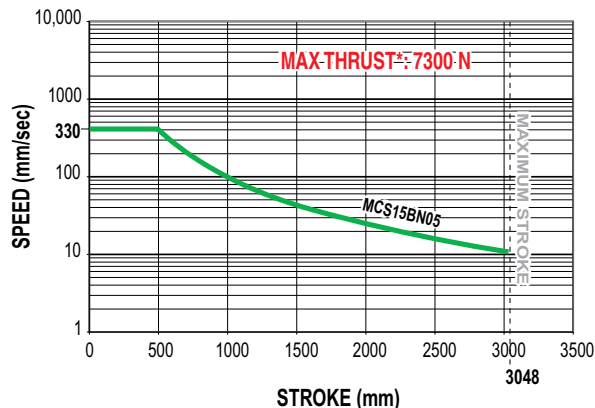

CRITICAL SPEED WITH 1/2" US CONVENTIONAL BALL SCREW

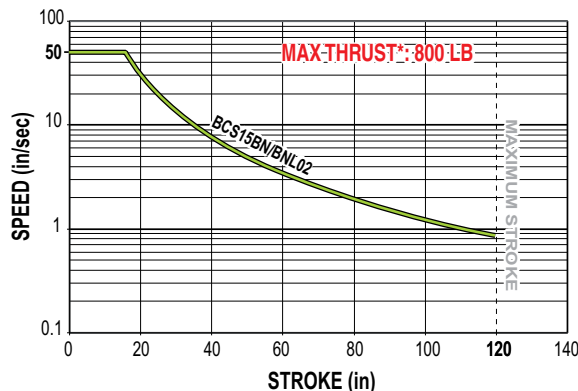

LIFE CALCULATION: 16mm METRIC BALL SCREW w/5mm LEAD

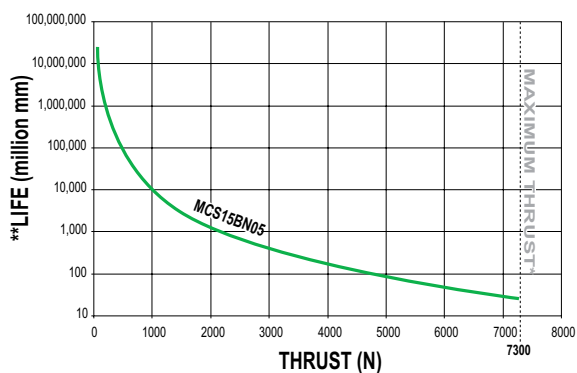

CRITICAL SPEED WITH 5/8" US CONVENTIONAL BALL SCREW

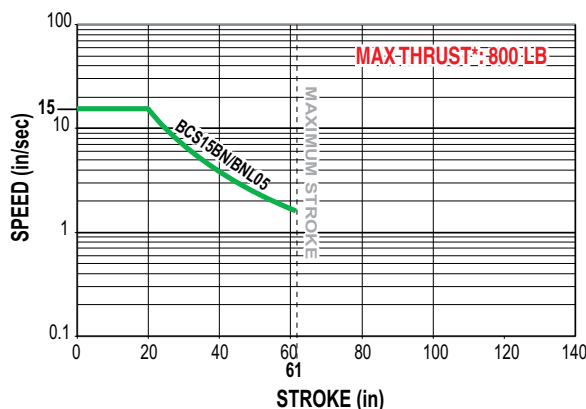

BN = Ball Nut
BNL = Ball Nut with Low-Backlash



* Maximum thrust reflects 90% reliability for 25 million linear millimeters of travel.

**Life indicates theoretical maximum life of screw only, under ideal conditions and does not indicate expected life of actuator.



LIFE CALCULATION: 1/2" w/2TPI & 5/8" w/5TPI US CONVENTIONAL BALL SCREW

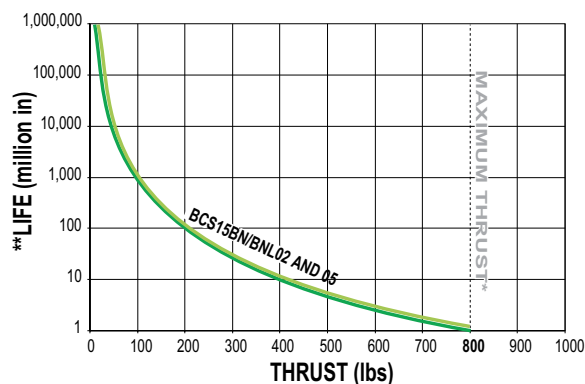

BCS15 Rodless Screw Drive Actuator

tolomatic.com/CAD Download 3D CAD
Always use CAD solid model to determine critical dimensions



DIMENSIONS

BCS15 ACTUATOR AND OPTIONS

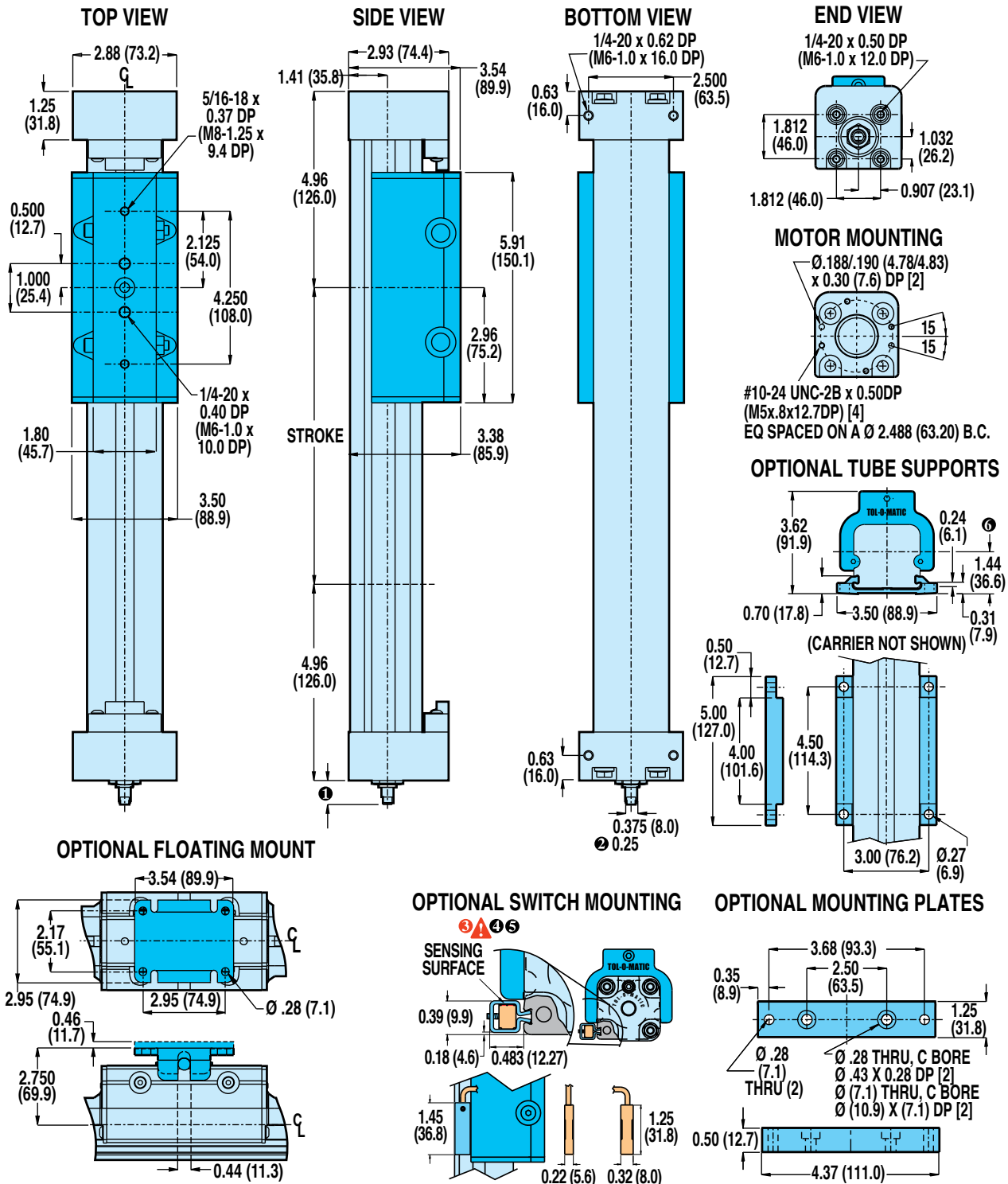

1 SHAFT LENGTH

In-line mounting	0.65 (16.5)
Extended shaft for RP & 23-frame motor	1.94 (49.3)
Extended shaft for RP & 34-frame motor	2.15 (54.6)
Extended shaft for RP & 40-frame motor	2.31 (58.7)
Extended shaft for purchases prior to 6/24/02	1.90 (48.2)

2 FOR 1/2" 2TPI BALL-SCREW STYLE ONLY

3 CAUTION: DO NOT OVERTIGHTEN SWITCH HARDWARE WHEN INSTALLING

4 NOTE: The scored face of the switch indicates the sensing surface and must face toward the magnet

5 NOTE: Some actuators require switch mounting on a specific side of the actuator. Call Tolomatic 1-800-328-2174 for details

6 NOTE: Optional tube supports or mounting plates may not always provide enough clearance between their mounting surfaces and in-line or reverse parallel motor mounting hardware.

Unless otherwise noted, all dimensions shown are in inches (Dimensions in parenthesis are in millimeters)

BCS15 Rodless Screw Drive Actuator

tolomatic.com/CAD Download 3D CAD
Always use CAD solid model to determine critical dimensions



DIMENSIONS

BCS15: IN-LINE MOUNT FOR MOTORS AND GEARHEADS

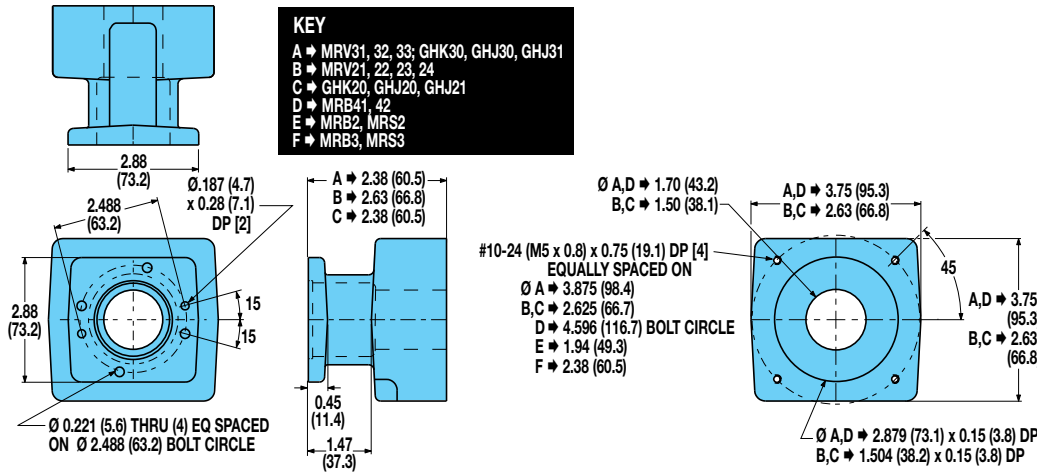

For gearhead dimensions and specifications, refer to literature #3600-4161

NOTE: MRB & MRV motors are discontinued contact Tolomatic for information on YMH (Your Motor Here)

BCS15: REVERSE PARALLEL MOUNTING

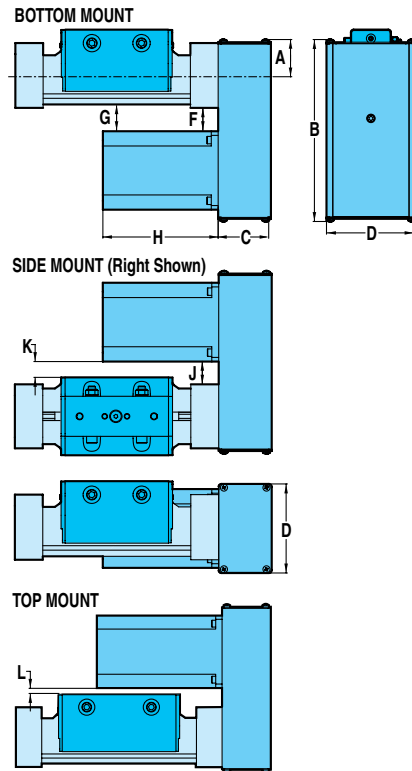

SPECIFICATIONS

	WEIGHT OF REDUCTION DRIVE		REDUCTION INERTIA AT MOTOR SHAFT	
	1:1	2:1	1:1	2:1
	kg	kg	kg-cm ²	kg-cm ²
NEMA 23 Frame	0.9843	1.0886	0.2043	0.2767
NEMA 34 Frame	1.1839	1.2882	0.2043	0.2767

	WEIGHT OF REDUCTION DRIVE		REDUCTION INERTIA AT MOTOR SHAFT	
	1:1	2:1	1:1	2:1
	lbs	lbs	lb-in ²	lb-in ²
NEMA 23 Frame	2.17	2.40	0.070	0.095
NEMA 34 Frame	2.61	2.84	0.070	0.095

REDUCTION EFFICIENCY: 0.95

DIMENSIONS

	A	B	C	D	F	G	Size	H*	J	K	L
	mm	mm	mm	mm	mm	mm		mm	mm	mm	mm
NEMA 23 Frame	36.6	189.4	54.0	82.6	43.2	47.0	21	120.7	42.4	47.2	25.3
							22	146.1			
							23	171.5			
							24	196.9			
NEMA 34 Frame	53.8	206.6	60.3	101.6	26.7	30.7	31	155.2	25.9	30.7	8.9
							32	186.9			
							33	218.7			

	A	B	C	D	F	G	Size	H*	J	K	L
	in.	in.	in.	in.	in.	in.		in.	in.	in.	in.
NEMA 23 Frame	1.44	7.46	2.13	3.25	1.70	1.85	21	4.75	1.67	1.86	0.98
							22	5.75			
							23	6.75			
							24	7.75			
NEMA 34 Frame	2.12	8.14	2.38	4.00	1.05	1.21	31	6.11	1.02	1.21	0.33
							32	7.36			
							33	8.61			

*H: Typical Motor Length

BCS20 Rodless Screw Drive Actuator



BALL SCREW SPECIFICATIONS

BCS20 BALL SCREW SPECIFICATIONS

CRITICAL SPEED WITH 20mm METRIC BALL SCREW

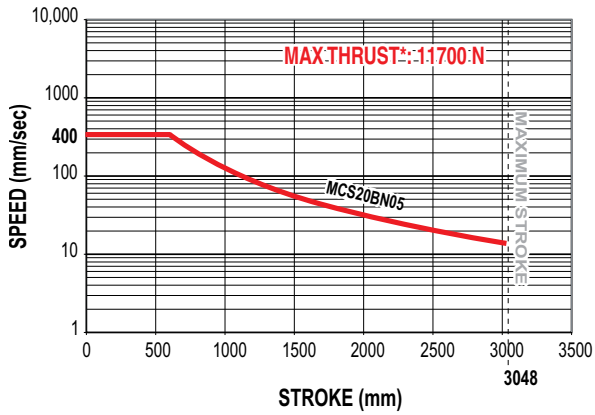

LIFE CALCULATION: 3/4" US CONVENTIONAL BALL SCREW, 2TPI

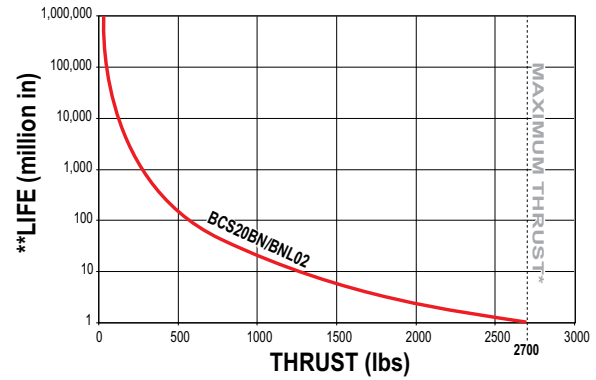

LIFE CALCULATION: 20mm METRIC BALL SCREW w/5mm LEAD

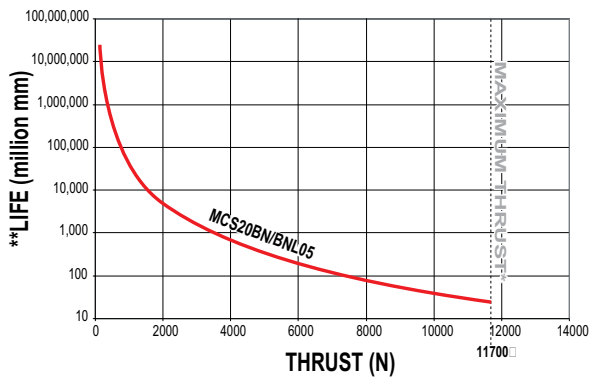

CRITICAL SPEED WITH 3/4" US CONVENTIONAL BALL SCREW, 5TPI

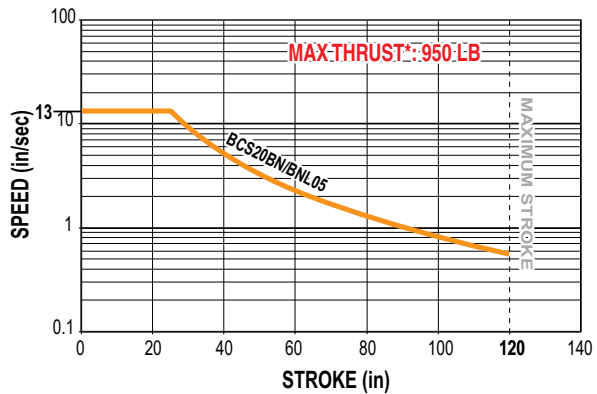

CRITICAL SPEED WITH 3/4" US CONVENTIONAL BALL SCREW, 2TPI

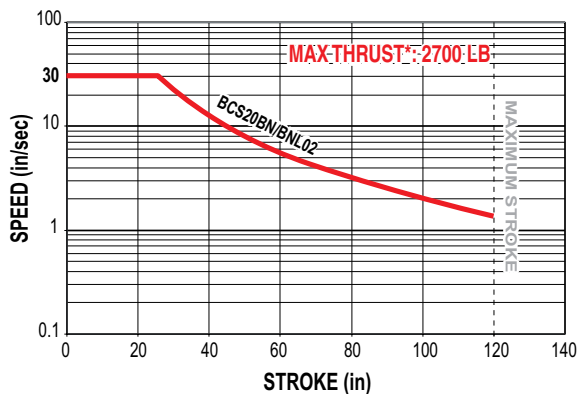

LIFE CALCULATION: 3/4" US CONVENTIONAL BALL SCREW, 5TPI

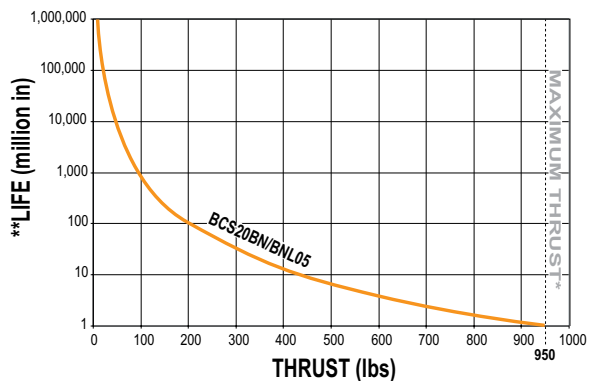

BN = Ball Nut
BNL = Ball Nut with Low-Backlash

* Maximum thrust reflects 90% reliability for 25 million linear millimeters of travel.

**Life indicates theoretical maximum life of screw only, under ideal conditions and does not indicate expected life of actuator.

BCS20 Rodless Screw Drive Actuator

tolomatic.com/CAD Download 3D CAD
Always use CAD solid model to
determine critical dimensions



DIMENSIONS

BCS20 ACTUATOR AND OPTIONS

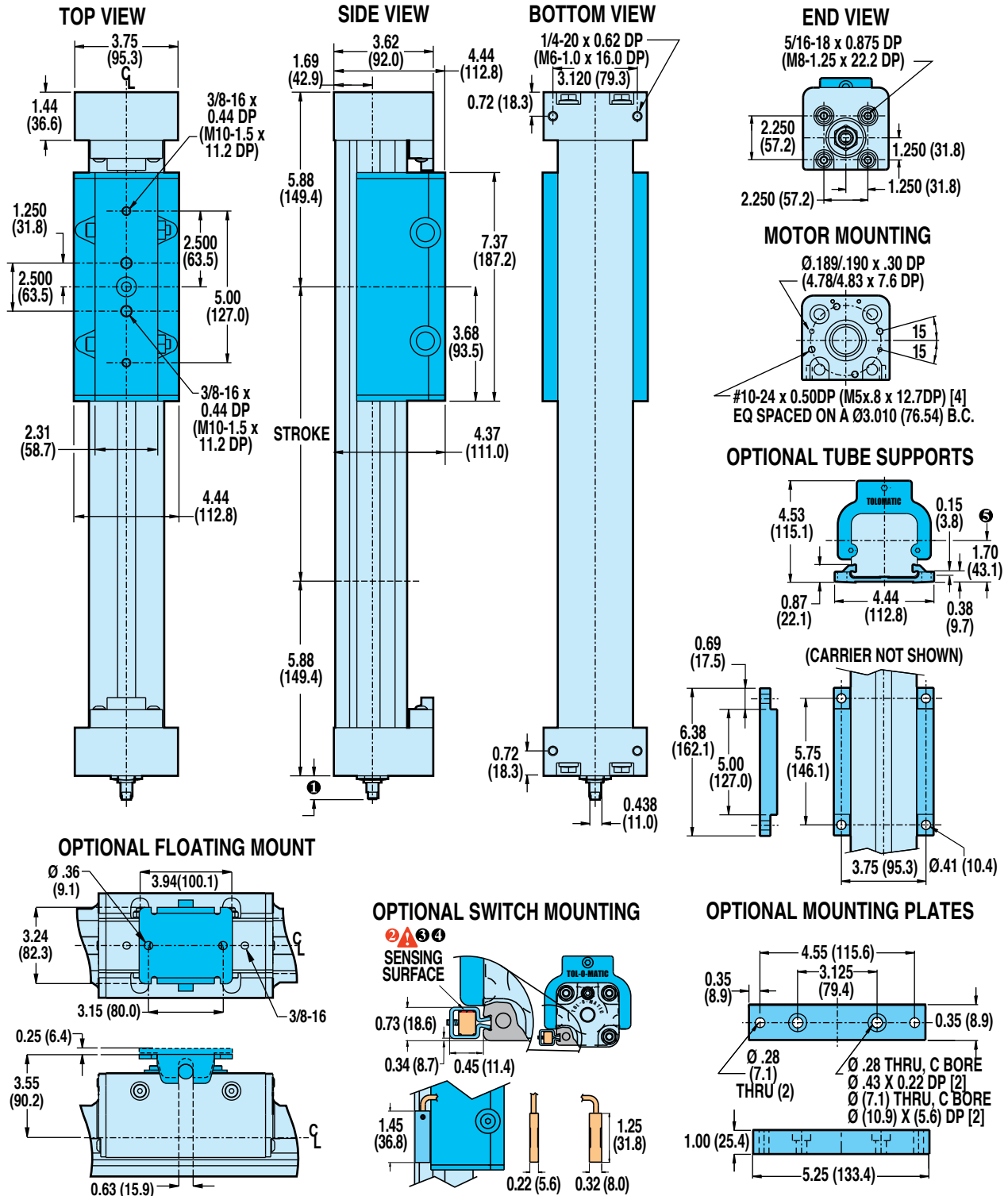

1 SHAFT LENGTH

In-line mounting	0.78 (19.8)
Extended shaft for RP & 23-frame motor	2.16 (54.9)
Extended shaft for RP & 34-frame motor	2.16 (54.9)
Extended shaft for RP & 40-frame motor	2.31 (58.7)
Extended shaft for purchases prior to 6/24/02	2.28 (57.9)

2 CAUTION: DO NOT OVERTIGHTEN SWITCH HARDWARE WHEN INSTALLING

3 NOTE: The scored face of the switch indicates the sensing surface and must face toward the magnet

4 NOTE: Some actuators require switch mounting on a specific side of the actuator. Call Tolomatic 1-800-328-2174 for details

5 NOTE: Optional tube supports or mounting plates may not always provide enough clearance between their mounting surfaces and in-line or reverse parallel motor mounting hardware.

Unless otherwise noted, all dimensions shown are in inches (Dimensions in parenthesis are in millimeters)

BCS20 Rodless Screw Drive Actuator

tolomatic.com/CAD Download 3D CAD
Always use CAD solid model to determine critical dimensions



DIMENSIONS

BCS20: IN-LINE MOUNT FOR MOTORS AND GEARHEADS

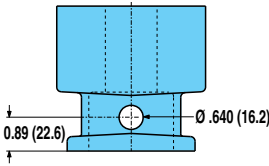

MOTORS KEY

- A → MRV3x, MRB3x
- B → MRV2x
- C → GHK20x, GHJ20x, GHJ21x, GHJ30x, GHJ31x, GHK30
- D → MRB4x
- E → MRB2, MRS2
- F → MRB3, MRS3

For gearhead dimensions and specifications, refer to literature #3600-4161

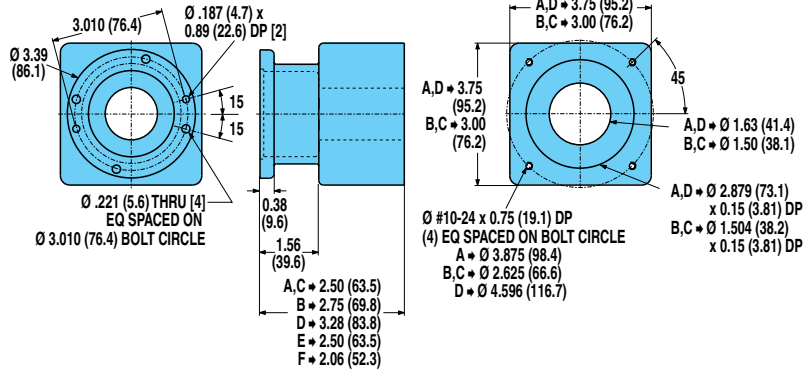

NOTE: MRB & MRV motors are discontinued contact Tolomatic for information on YMH (Your Motor Here)

BCS20: REVERSE PARALLEL MOUNTING

BOTTOM MOUNT

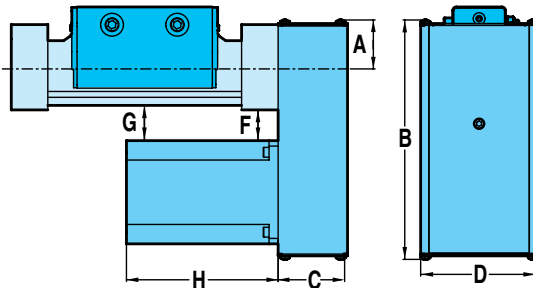

TOP MOUNT

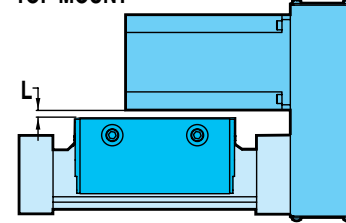

SIDE MOUNT (Right Shown)

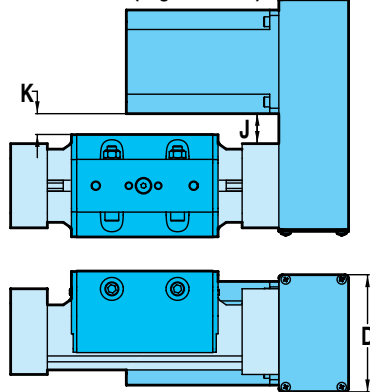

SPECIFICATIONS

	WEIGHT OF REDUCTION DRIVE		REDUCTION INERTIA AT MOTOR SHAFT			WEIGHT OF REDUCTION DRIVE		REDUCTION INERTIA AT MOTOR SHAFT	
	1:1	2:1	1:1	2:1		1:1	2:1	1:1	2:1
	kg	kg	kg-cm ²	kg-cm ²		lbs	lbs	lb-in ²	lb-in ²
NEMA 23 Frame	1.41	1.48	0.3447	0.2928	NEMA 23 Frame	3.11	3.27	0.118	0.100
NEMA 34 Frame	1.44	1.51	0.3447	0.2928	NEMA 34 Frame	3.18	3.34	0.118	0.100

REDUCTION EFFICIENCY: 0.95

DIMENSIONS

	A	B	C	D	F	G	Size	H*	J	K	L		A	B	C	D	F	G	Size	H*	J	K	L
	mm	mm	mm	mm	mm	mm		mm	mm	mm	mm			in.	in.	in.	in.	in.	in.		in.	in.	in.
NEMA 23 Frame	36.6	236.5	60.3	101.6	61.8	63.5	21	120.7	57.2	65.0	34.9	NEMA 23 Frame	1.44	9.31	2.38	4.00	2.44	2.50	21	4.75	2.25	2.56	1.38
							22	146.1											22	5.75			
							23	171.5											23	6.75			
							24	196.9											24	7.75			
NEMA 34 Frame	49.7	249.6	60.3	101.6	45.5	47.2	31	155.2	40.9	48.8	18.5	NEMA 34 Frame	1.96	9.83	2.38	4.00	1.79	1.86	31	6.11	1.61	1.92	0.73
							32	186.9											32	7.36			
							33	218.7											33	8.61			

*H: Typical Motor Length

BCS Rodless Screw Drive Actuator

SWITCHES

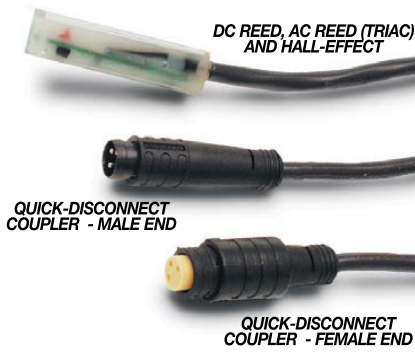

There are 10 sensing choices: DC reed, form A (open) or form C (open or closed); AC reed (Triac, open); Hall-effect, sourcing, PNP (open); Hall-effect, sinking, NPN (open); each with either flying leads or QD (quick disconnect). Commonly used to send analog signals to PLC (programmable logic controllers), TLL, CMOS circuit or other controller device. These switches are activated by the actuator's magnet.

Switches contain reverse polarity protection, QD cables are shielded; shield should be terminated at flying lead end.

If necessary to remove factory installed switches, be sure to reinstall on the same side of actuator with scored face of switch toward internal magnet.

SPECIFICATIONS

ORDER CODE	REED DC				REED AC		HALL-EFFECT DC			
	R T	R M	B T	B M	C T	C M	T T	T M	K T	K M
LEAD	5m	QD*	5m	QD*	5m	QD*	5m	QD*	5m	QD*
CABLE SHIELDING	Unshielded	Shielded†	Unshielded	Shielded†	Unshielded	Shielded†	Unshielded	Shielded†	Unshielded	Shielded†
SWITCHING LOGIC	"A" Normally Open		"C" Normally Open or Closed		Triac Normally Open		PNP (Sourcing) Normally Open		NPN (Sinking) Normally Open	
MECHANICAL CONTACTS	Single-Pole Single-Throw		Single-Pole Double-Throw		Single-Pole Single-Throw		NO, These Are Solid State Components			
COIL DIRECT	Yes		Yes		Yes		—			
POWER LED	None		None		None		None		None	
SIGNAL LED	Red		None		None		Red		Red	
OPERATING VOLTAGE	200 Vdc max.		120 Vdc max.		120 Vac max.		5 - 25 Vdc			
OUTPUT RATING	—		—		—		25 Vdc, 200mA dc			
OPERATING TIME	0.6 msec max. (including bounce)		0.7 msec max. (including bounce)		—		< 10 micro sec.			
OPERATING TEMPERATURE	-40°F [-40°C] to 158°F [70°C]						0°F [-18°C] to 150°F [66°C]			
RELEASE TIME	1.0 msec. max.				—		—			
ON TRIP POINT	—				—		150 Gauss maximum			
OFF TRIP POINT	—				—		40 Gauss minimum			
**POWER RATING (WATTS)	10.0 §		3.0 §§		10.0		5.0			
VOLTAGE DROP	2.6 V typical at 100 mA		NA		—		—			
RESISTANCE	0.1 Ω Initial (Max.)				—		—			
CURRENT CONSUMPTION	—				1 Amp at 86°F [30°C]	0.5 Amp at 140°F [60°C]	200 mA at 25 Vdc			
FREQUENCY	—				47 - 63 Hz		—			
CABLE MIN. BEND RADIUS	STATIC				0.630" [16mm]					
	DYNAMIC				Not Recommended					

CAUTION: DO NOT OVER TIGHTEN SWITCH HARDWARE WHEN INSTALLING!

**** WARNING:** Do not exceed power rating (Watt = Voltage X Amperage). Permanent damage to sensor will occur.

*QD = Quick Disconnect; Male coupler is located 6" [152mm] from sensor, Female coupler to flying lead distance is 197" [5m] also see Cable Shielding specification above

REPLACEMENT OF QD SWITCHES MANUFACTURED BEFORE JULY 1, 1997: It will be necessary to replace or rewire the female end coupler.



Reed Switch Life Expectancy: Up to 200,000,000 cycles (depending on load current, duty cycle and environmental conditions)

†Shielded from the female quick disconnect coupler to the flying leads. Shield should be terminated at flying lead end.

§ Maximum current 500mA (not to exceed 10VA) Refer to Temperature vs. Current graph and Voltage Derating graph

BCS Rodless Screw Drive Actuator

PERFORMANCE

TEMP. vs CURRENT, DC REED

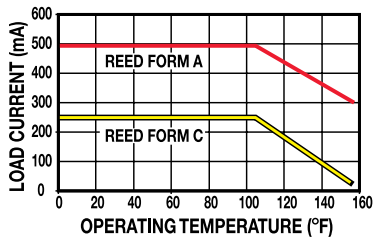

TEMP. vs CURRENT, AC REED

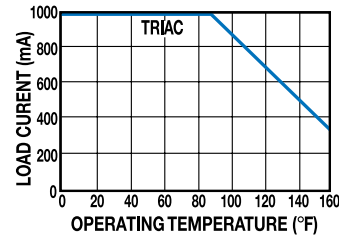

VOLTAGE DERATING, DC REED

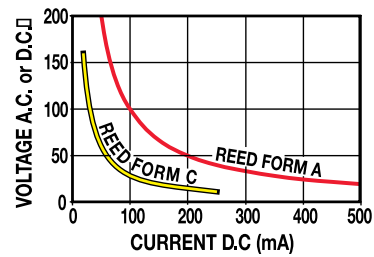

WIRING DIAGRAMS

RT & **R**M DC REED, FORM A

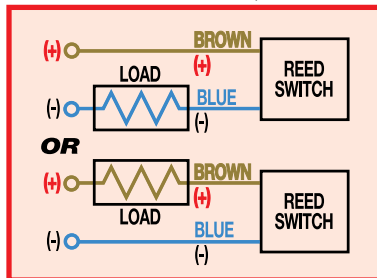

CT & **C**M AC REED, TRIAC

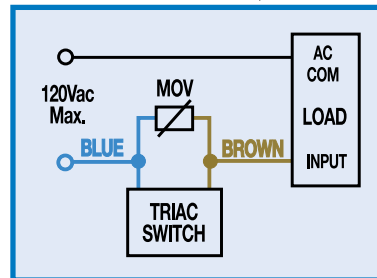

BT & **B**M DC REED, FORM C

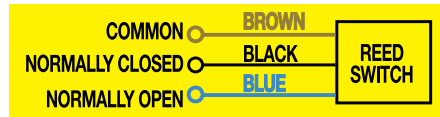

TT & **T**M HALL-EFFECT, SOURCING, PNP

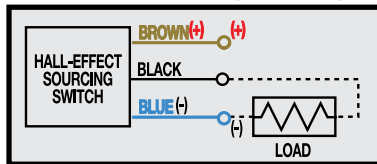

KT & **K**M HALL-EFFECT, SINKING, NPN

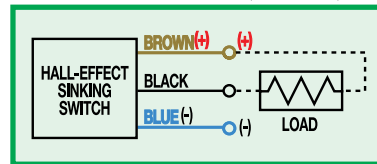

INSTALLATION INFORMATION



▲
THE NOTCHED FACE OF THE SWITCH INDICATES THE SENSING SURFACE AND MUST FACE TOWARD THE MAGNET.



sizeit.tolomatic.com
for fast, accurate
actuator selection

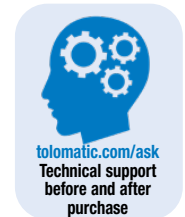

tolomatic.com/ask
Technical support
before and after
purchase

COMPILE APPLICATION REQUIREMENTS

APPLICATION DATA WORKSHEET

Fill in known data. Not all information is required for all applications

ORIENTATION

Horizontal

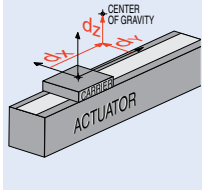

Side

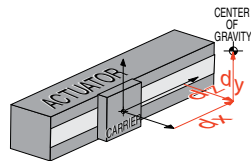

Horizontal Down

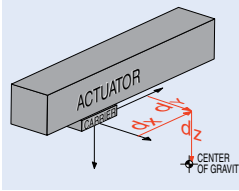

Vertical

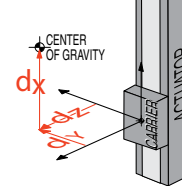

Angled °

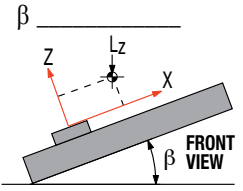
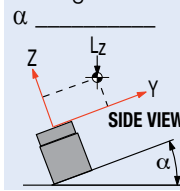

Load attached to carrier OR Load supported by other mechanism

DISTANCE FROM CENTER OF CARRIER TO LOAD CENTER OF GRAVITY

d_x _____
 d_y _____
 d_z _____

inch (U.S. Standard)

millimeter (Metric)

STROKE LENGTH _____

inch (U.S. Standard)

millimeters (Metric)

NOTE: If load or force on carrier changes during cycle use the highest numbers for calculations

LOAD _____

lb. (U.S. Standard)

kg. (Metric)

THRUST REQUIRED

lbf. (U.S. Standard)

N (Metric)

F_z _____
 F_y _____

BENDING MOMENTS APPLIED TO CARRIER

in.-lbs. (U.S. Standard)

N-m (Metric)

M_x _____
 M_y _____
 M_z _____

PRECISION

Repeatability _____

inch

millimeters

OPERATING ENVIRONMENT

Temperature, Contamination, etc.

MOVE PROFILE

Move Distance _____

inch

millimeters

Dwell Time After Move _____

Max. Speed _____

in/sec

mm/sec

MOVE TIME _____

sec

NO. OF CYCLES _____

per minute

per hour

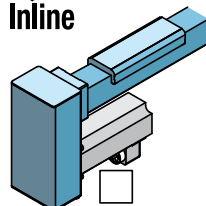
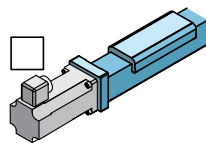

Inline

Reverse Parallel

MOTION PROFILE

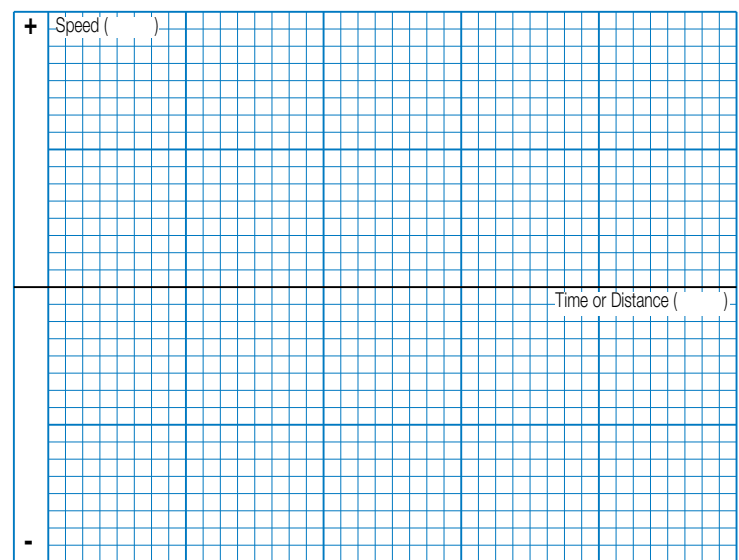

Graph your most demanding cycle, including accel/decel, velocity and dwell times. You may also want to indicate load variations and I/O changes during the cycle. Label axes with proper scale and units.



USE THE TOLOMATIC SIZING AND SELECTION SOFTWARE AVAILABLE ON-LINE AT www.tolomatic.com OR... CALL TOLOMATIC 1-800-328-2174 with the above information. We will provide any assistance needed to determine the proper MX actuator for the job.

FAX 1-763-478-8080

CONTACT INFORMATION

Name, Phone, Email
 Co. Name, Etc.

SELECTION GUIDELINES

The process of selecting a load bearing actuator for a given application can be complex. It is highly recommended that you contact Tolomatic or a Tolomatic Distributor for assistance in selecting the best actuator for your application. The following overview of the selection guidelines are for educational purposes only.

1 CHOOSE ACTUATOR SIZE

Choose an actuator that has the thrust, speed and moment load capacity to move the load. Use the Critical Speed graphs (page BCS_4-5) for the screw and the Moment and Load Capacity table (pg. BCS_9) for the actuator.

2 COMPARE LOAD TO MAXIMUM LOAD CAPACITIES

Calculate the application load (combination of load mass and forces applied to the carrier) and application bending moments (sum of all moments M_x , M_y , and M_z applied to the carrier). Be sure to evaluate the magnitude of dynamic inertia moments. When a rigidly attached load mass is accelerated or decelerated, its inertia induces bending moments on the carrier. Careful attention to how the load is decelerated at the end of the stroke is required for extended actuator performance and application safety. If either load or any of your moments exceed figures indicated in the Moment and Load Capacity table (pg. BCS_9) for the actuator consider:

- 1) Higher capacity bearing style
- 2) A larger actuator size
- 3) Auxiliary carrier
- 4) External guide system

3 CALCULATE LOAD FACTOR LF

For loads with a center of gravity offset from the carrier account for both applied (static) and dynamic loads. The load factor (LF) must not exceed the value of 1.

$$LF = \frac{M_x}{M_{x_{max}}} + \frac{M_y}{M_{y_{max}}} + \frac{M_z}{M_{z_{max}}} + \frac{F_y}{F_{y_{max}}} + \frac{F_z}{F_{z_{max}}} \leq 1$$

If LF does exceed the value of 1, consider the four choices listed in step #2.

4 ESTABLISH YOUR MOTION PROFILE AND CALCULATE ACCELERATION RATE

Using the application stroke length and maximum carrier velocity (or time to complete the linear motion), establish the motion profile. Select either triangular (accel-decel) or trapezoidal (accel-constant speed-decel) profile. Now calculate the maximum acceleration and deceleration rates of the move. Speed should not exceed critical speed value as shown on graphs (page BCS_4-5) for the screw/nut combination cho-

SPEED FACTOR

FOR APPLICATIONS WITH HIGH SPEED OR SIGNIFICANT SHOCK AND VIBRATION: Calculated values of loads and bending moments must be increased by speed factor from the graph below to obtain full rated life of profiled rail bearing system.

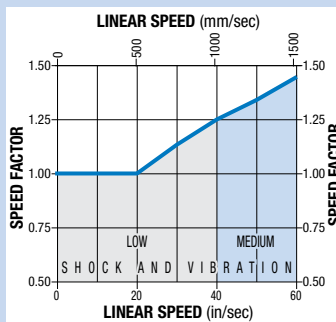

sen. Also, do not exceed safe rates of dynamic inertia moments determined in step #3.

5 SELECT THE LEAD SCREW

Based on the application requirements for accuracy, backlash, quiet operation, life, etc. select the appropriate lead screw type (Acme screw with a solid nut or ball screw with a standard or anti-backlash nut) and the pitch (lead). For additional information on screw selection, consult "Which Screw? Picking the Right Technology" (#9900-4644) available at www.tolomatic.com.

6 SELECT MOTOR (GEARHEAD IF NECESSARY) AND DRIVE

To help select a motor and drive, use the sizing equations located in the Engineering Resources section [ENGR] to calculate the application thrust and torque requirements. Refer to Motor sections [MRV] & [MRS] to determine the motor and drive.

7 DETERMINE TUBE SUPPORT/ MOUNTING PLATE REQUIREMENTS

- Consult the Support Recommendations graph for the model selected (page BCS_8)
- Cross reference the application load and maximum distance between supports
- Select the appropriate number of tube supports, and mounting plates if required for motor and adapter clearance.

8 CONSIDER OPTIONS

- Choose metric or inch (US conventional) load mounting.
- Switches - Reed, Solid State PNP or NPN, all available normally open or normally closed
- **FIL** Floating mount bracket - used when lack of parallelism occurs between the actuator and an externally guided and supported load

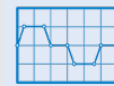

sizeit.tolomatic.com
for fast, accurate
actuator selection



tolomatic.com/ask
Technical support
before and after
purchase

S SOLID BEARING 2:1 RULE

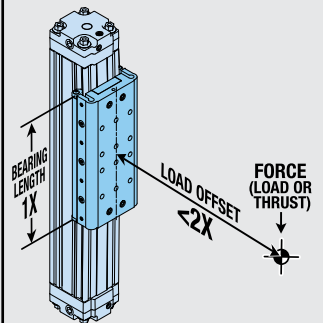

For applications using **BICS** actuator, binding or interrupted motion may occur if the load offset is equal to or greater than twice the bearing length (1X).

LOAD OFFSET is defined as: the distance from the applied force (or the load center of gravity) to the centerline of the carrier.

If the load offset cannot be changed consider:

- 1.) Higher capacity bearing style
- 2.) Larger Bore Cylinder
- 3.) Auxiliary Carrier
- 4.) Add External Guides

BCS Rodless Screw Drive Actuators

ORDERING

BASE MODEL SPECIFICATIONS

BCS 20 B N 0 2 S K 4 5 R P L 1

MODEL TYPE

BCS BCS Series US Conventional Screw Drive

SIZE

10, 15, 20

NUT/SCREW CONFIGURATION

INCH MODELS (US Conventional)	METRIC MODELS†
SOLID NUT / PITCH (turn/in)	SOLID NUT / LEAD (mm/turn)
SN01 SN02 SNA02 SN05	SN25 SN12
BALL NUT / PITCH (turn/in)	BALL NUT / LEAD (turn/in)
BN02 BNL02 BN05 BNL05 BN08 BNL08	BN05 BNL05 BN08 BNL08

† The metric version provides metric tapped holes for mounting of the load to the carrier and of the actuator to mounting surfaces

STROKE LENGTH & MOUNTING TYPE

SK __ . __ Stroke, enter desired stroke length in inches

SM† __ . __ Stroke, enter desired stroke length in millimeters

NOTE: Actuator mounting threads and mounting fasteners will be either inch or metric; depending on how stroke length is indicated.

SK = inch mounting
SM = metric mounting

† The metric version provides metric tapped holes for mounting of the load to the carrier and of the actuator to mounting surfaces

OPTIONS SPECIFICATIONS

DC 1 8 K T 2 M P 2

MOTOR MOUNTING / REDUCTIONS

(must choose one)

LMI In-Line mounting
LME23 Ext. shaft for RP & 23 frame motor
LME34 Ext. shaft for RP & 34 frame motor
****LMX** Extended shaft - old style (see note)
****For replacement actuators with extended motor shafts purchased prior to 6/24/02 use LMX**

A motor size and code must be selected when specifying a reverse-parallel mounting configuration.

RPL1 1:1 Reverse-Parallel mount left
RPR1 1:1 Reverse-Parallel mount right
RPB1 1:1 Reverse-Parallel mount bottom
RPT1 1:1 Reverse-Parallel mount top
RPL2 2:1 Reverse-Parallel mount left
RPR2 2:1 Reverse-Parallel mount right
RPB2 2:1 Reverse-Parallel mount bottom
RPT2 2:1 Reverse-Parallel mount top

AUXILIARY CARRIER

DC __ Auxiliary Carrier, then center-to-center spacing desired in in inches (**SK**) or millimeters (**SM**).

(Same unit of measure as stroke length is required)
Center-to-center spacing between carriers adds to overall length of the actuator, this distance will not be subtracted from stroke length specified in the previous step.

SWITCHES

RM _ Reed Switch (Form A) with 5-meter lead/QD (*quick-disconnect*), & quantity
RT _ Reed Switch (Form A) with 5-meter lead, and quantity desired
BM _ Reed Switch (Form C) with 5-meter lead/QD, and quantity desired
BT _ Reed Switch (Form C) with 5-meter lead, and quantity desired
KM _ Hall-effect Sinking Switch with 5-meter lead/QD, and quantity desired
KT _ Hall-effect Sinking Switch with 5-meter lead, and quantity desired
TM _ Hall-effect Sourcing Switch with 5-meter lead/QD, and quantity desired
TT _ Hall-effect Sourcing Switch with 5-meter lead, and quantity desired
CM _ TRIAC Switch with 5-meter lead/QD, and quantity desired
CT _ TRIAC Switch with 5-meter lead, and quantity desired

SUPPORTS AND MOUNTING PLATES

(both may be selected)

TS _ Tube Supports plus quantity desired
MP2 Mounting Plates, 2 in kit

FLOATING MOUNT

FL _ Floating Mount Bracket

FOOD GRADE LUBRICATION

LUB _ Grease, Food/Drug

NOTE: Brakes mounted on reverse parallel motor mounts (especially in vertically positioned actuators) will not prevent back driving of the screw and the load falling under gravity in the event of a timing belt failure. An inline motor mount with a fail-safe brake mounted directly to the actuator shaft or a special geared or thru-shaft reverse parallel construction should be considered if a brake is required in a safety critical application. Contact Tolomatic for alternate reverse parallel brake mounting options.

Gearheads may be used with reverse parallel motor mounts. However, the torque on the belt and internal RP components must remain below the capabilities of the assembly to prevent belt slipping or premature failure. Contact Tolomatic for additional information if required.

⚠ Not all codes listed are compatible with all options.

Use the Sizing Software to determine available options and accessories based on your application requirements.

FIELD RETROFIT KITS

ITEM	BCS10_SK	BCS15_SK	BCS20_SK	BCS10_SM	BCS15_SM	BCS20_SM
Tube Supports	4510-1010	4515-1010	4520-1010	4510-1010	4515-1010	4520-1010
Mounting Plates	0910-9133	0915-9135	0920-9038	0510-9105	0515-9138	0520-9105



sizeit.tolomatic.com
for fast, accurate
actuator selection



tolomatic.com/ask
Technical support
before and after
purchase

The Tolomatic Difference Expect More From the Industry Leader:



INNOVATIVE PRODUCTS

Solutions with Endurance TechnologySM for challenging applications.



FAST DELIVERY

Built-to-order with configurable stroke lengths and flexible mounting options.

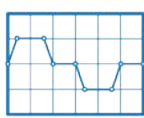

ACTUATOR SIZING

Size and select electric actuators with our online software.



YOUR MOTOR HERE[®]

Match your motor to compatible mounting plates with Tolomatic actuators.



CAD LIBRARY

Download 2D or 3D CAD files for Tolomatic products.



TECHNICAL SUPPORT

Get a question answered or request a virtual design consultation with one of our engineers.

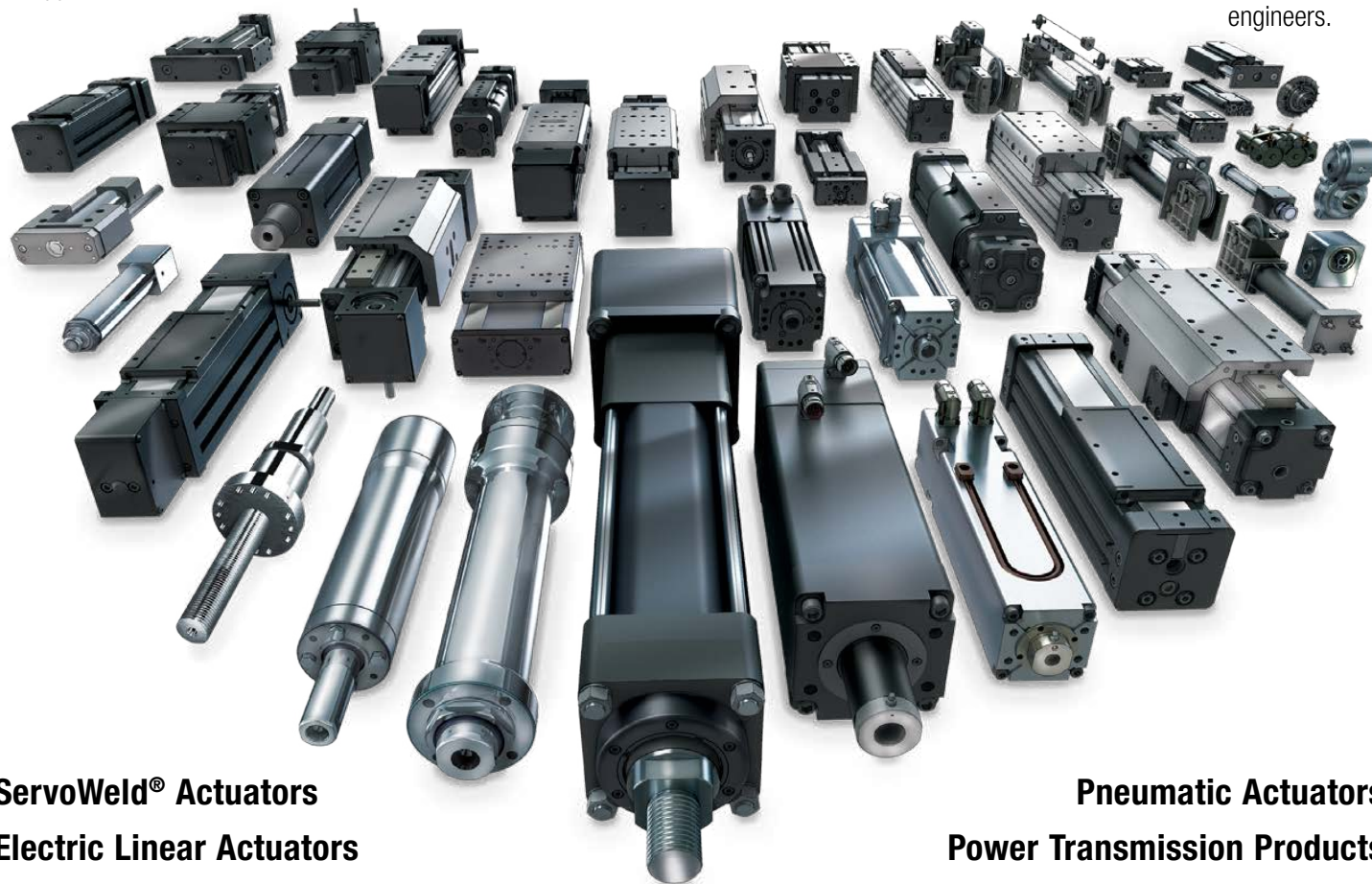

ServoWeld[®] Actuators
Electric Linear Actuators

Pneumatic Actuators
Power Transmission Products



MADE IN U.S.A.

TolomaticTM

EXCELLENCE IN MOTION

COMPANY WITH
QUALITY SYSTEM
CERTIFIED BY DNV
= ISO 9001 =
Certified site: Hamel, MN

USA - Headquarters

Tolomatic Inc.

3800 County Road 116
Hamel, MN 55340, USA

Phone: (763) 478-8000

Toll-Free: **1-800-328-2174**

sales@tolomatic.com

www.tolomatic.com

MEXICO

Centro de Servicio

Parque Tecnológico Innovación
Int. 23, Lateral Estatal 431,
Santiago de Querétaro,
El Marqués, México, C.P. 76246

Phone: +1 (763) 478-8000

help@tolomatic.com

EUROPE

Tolomatic Europe GmbH

Elisabethenstr. 20
65428 Rüsselsheim
Germany

Phone: +49 6142 17604-0

help@tolomatic.eu

www.tolomatic.com/de-de

CHINA

Tolomatic Automation Products (Suzhou) Co. Ltd.

No. 60 Chuangye Street, Building 2
Huqu District, SND Suzhou
Jiangsu 215011 - P.R. China

Phone: +86 (512) 6750-8506

Tolomatic_China@tolomatic.com

All brand and product names are trademarks or registered trademarks of their respective owners. Information in this document is believed accurate at time of printing. However, Tolomatic assumes no responsibility for its use or for any errors

that may appear in this document. Tolomatic reserves the right to change the design or operation of the equipment described herein and any associated motion products without notice. Information in this document is subject to change without notice.

Visit www.tolomatic.com for the most up-to-date technical information