

Compact ServoWeldTM Actuator

Patent Pending

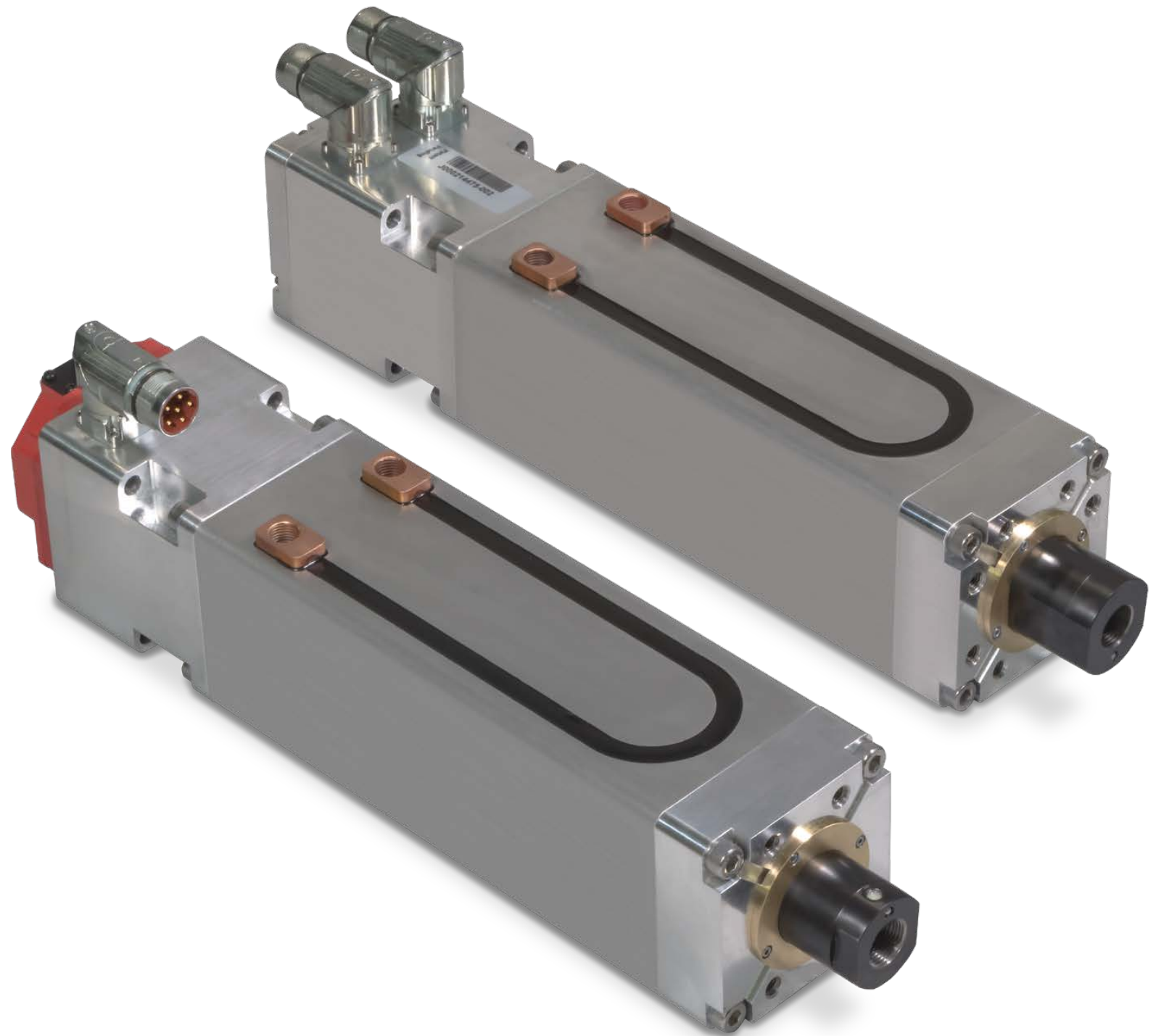

INTEGRAL MOTOR HIGH THRUST ACTUATOR

ServoWeld CSWX

Tolomatic is the world's leading manufacturer of integrated servo actuators for resistance spot welding, used by the world's top weld gun OEM's and numerous global vehicle manufacturers.



Superior Integrated Servo Motor Actuators

Tolomatic's ServoWeld family of integrated servo actuators are designed for best-in-class performance with the factors that are most important for resistance spot welding gun applications.

NUMBER OF WELDS/ PRODUCT LIFE

Tolomatic's superior roller screw design has the **highest dynamic load rating for more welds** than any competitive technology (other roller screws, ball screw, pneumatic).

FORCE REPEATABILITY

Skewed winding designed for welding minimizes motor cogging and **provides industry best actuator force repeatability:** • $\pm 3\%$ Over the Lifetime of the Actuator

EFFICIENCY

All elements of actuator (winding, screw, rod scraper, bearings) are designed to optimize the efficiency of the actuator system and provide the **most energy efficient solution on the market.**

WELDS/ MINUTE

All elements of the actuator (winding, screw, rod scraper, bearings) are designed to last and run as cool as possible in welding applications, with the ability to add water cooling as an option. This means **more welds per minute than any competitive technology** (other roller screws, ball screw, pneumatic).

WEIGHT

Tolomatic integrated servo actuators minimize weight when designed into the weldgun. Additionally, Tolomatic can customize actuators for a specific weldgun applications to provide **industry leading light weight designs.**

LIFETIME COST

By building the longest lasting, most efficient and highest weld per minute actuators on the market, Tolomatic actuators provide the **lowest total cost per spot weld.**

ServoWeld Applications

PINCH STYLE

"X" STYLE

Additional Welding Applications:

- Pedestal Welding
- Projection Welding

"C" STYLE

Typical Robotic ServoWeld Installation

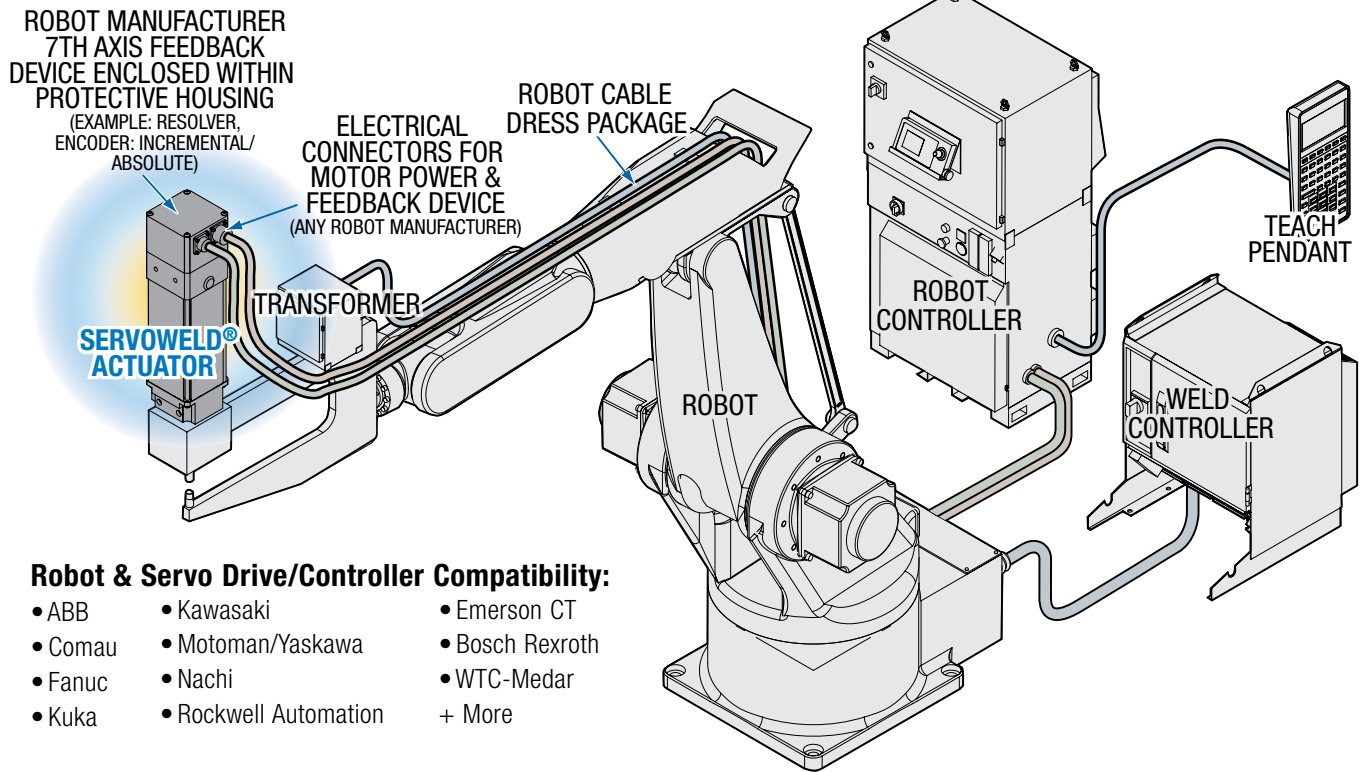

Tolomatic Offers the Broadest, Most Capable Family of Integrated Servo Actuators for Resistance Spot Welding

Model:	GSWA	SWA/SWB	CSWX
Number of Welds¹ (millions):	20+	20+ (10+ SWB)	30+ (20+ CSW)
Re-lubrication without Disassembly:	Yes ⁴	Yes	Yes
Peak Force:	36.7 kN [8,243 lbf]	24.0 kN [5,395 lbf] SWA 22.0 kN [4,950 lbf] SWB	18.0 kN [4,047 lbf] CSWX 15.6 kN [3,500 lbf] CSW
Actuator Output Force² (Lifetime) Repeatability:	±3%	±3% (±5% SWB)	±3%
Weight (size 33,3)³ (size 44,04)³ (size 55)³:	8.3 kg [18.3 lb] 13.8 kg [30.4 lb] 30.5 kg [67.2 lb]	7.2 kg [15.9 lb] 14.2 kg [31.2 lb]	min: 10.2 kg [22.6 lb]
Water Cooling:	Optional	Optional	Optional
Manual Override:	Optional	No	Optional
Full Force Direction:	Push and Pull	Push	Push and Pull

¹ Based on properly lubricated ServoWeld unit used as recommended in user manual. Weld schedule, tip force, environment and lubrication are factors in the total number of welds achievable with ServoWeld actuators.

² At weld force

³ Weight varies with choice of feedback device and mounting options

⁴ Some exceptions, see GSWA user manual

CSWX INTEGRATED MOTOR ACTUATOR

ENDURANCE TECHNOLOGYSM

A Tolomatic Design Principle

Endurance Technology features are designed for maximum durability to provide extended service life.

	CSWX
Typical Weld Estimated Life	30 million
Warranty	24 months
Roller Screw	RN05XR & RN10
Motor	3 stack & 4 stack

REPEATABILITY

Force repeatability of $\pm 3\%$ for entire life of actuator

PEAK FORCE

18 kN (4047 lbf)

INTEGRATED WATER COOLING OPTION

- 23% more efficient compared to external designs
- Allows for increased duty cycle and welds/hour

LARGE THRUST TUBE

40% larger diameter for greater stability

OPTIONAL INTEGRATED ANTI-ROTATE

Optional machined 'Double-D' thrust rod designed to provide internal anti-rotation

ADDITIONAL OPTIONS:

- Long Stroke
- Manual Override

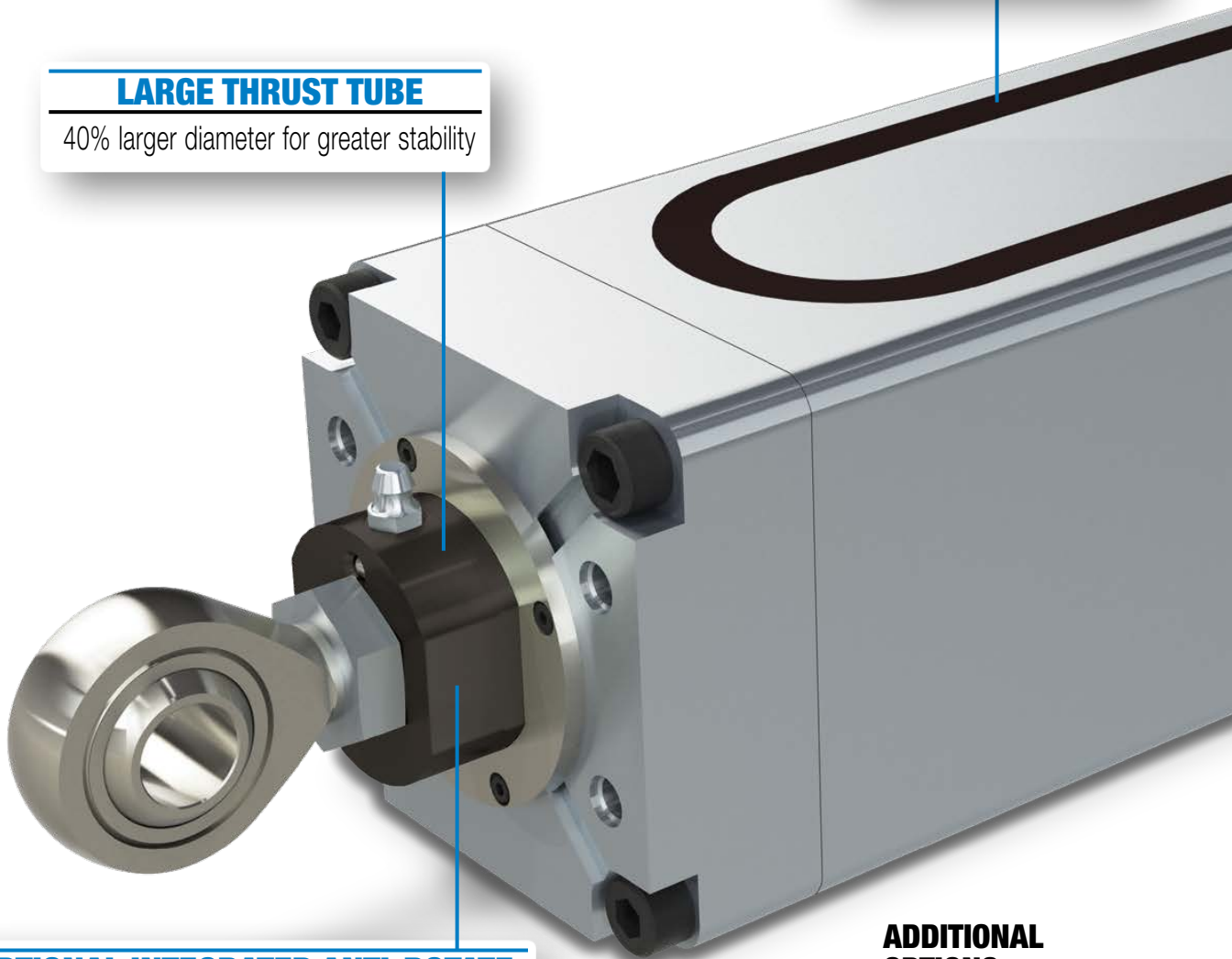

INTEGRATED FORCE FEEDBACK OPTION

- Integrated Piezo-electric sensor
- Scaled output 0-10 V

STANDARD STROKE LENGTHS

- 160 mm (6.3 in)
- 200 mm (7.9 in)
- 250 mm (9.8 in)
- 300 mm (11.8 in)

HIGH SPEED

- 10 mm lead option
- 700 mm/s (27.5 in/sec)

MID-TRUNNION MOUNTING



Rectangular extrusion is easy to adapt to a wide variety of mounting locations

TOLOMATIC PLANETARY ROLLER SCREW



- 5mm XR
- 10mm

CSWX GUIDED INTEGRATED MOTOR ACTUATOR

ENDURANCE TECHNOLOGYSM

A Tolomatic Design Principle

Endurance Technology features are designed for maximum durability to provide extended service life.

ROD WIPER WITH SCRAPER

Prevents contaminants from entering the actuator for extended life

ROBUST BUSHINGS

- Large bushings provide additional side loading support for the thrust tube protecting the screw assembly
- Eliminates external guide on RSW chassis

DOUBLE-D ANTI-ROTATE

- Simple, efficient anti-rotate system
- Provides some additional side loading support

STANDARD STROKE LENGTHS

- 160 mm (6.3 in)
- 200 mm (7.9 in)
- 250 mm (9.8 in)
- 300 mm (11.8 in)

ADDITIONAL OPTIONS:

- Long Stroke
- Manual Override
- Spring held / 24V electrically released brake

LARGE THRUST TUBE

- Surface has excellent corrosion resistance, surface hardness and is very resistant to adherence of weld slag, water and other potential contaminants
- 40% larger diameter for greater stability

INTERNAL BUMPERS

Bumpers protect the screw and nut assembly from damage at end of stroke

INTEGRATED WATER COOLING OPTION

- 23% more efficient compared to external designs
- Allows for increased duty cycle and welds/hour

INTEGRATED FORCE FEEDBACK OPTION

- Integrated Piezo-electric sensor
- Scaled output 0-10 V

MULTIPLE MOTOR WINDINGS

YOU CAN CHOOSE:

- 460VAC or 230VAC rated windings potted directly into actuator housing
- Integral thermal switch for over temperature protection

TOLOMATIC PLANETARY ROLLER SCREW

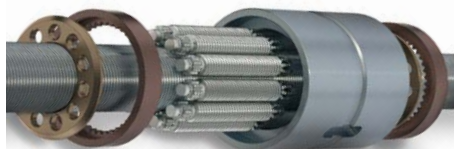

- 5mm XR
- 10mm

HIGH SPEED

- 10 mm lead option
- 700 mm/s (27.5 in/sec)

IP65



IP65 rating protects actuator from ingress of water, weld slag and other debris (static)

INTEGRAL MOUNTING

- Four holes on anti-rotate assembly are available for direct mounting or addition of customized options
- 2 dowel pins are located a bottom of anti-rotate unit for accurate positioning

ServoWeld CSWX - Integrated Motor Actuator

Table 1: Performance & Mechanical Specifications:

SERIES		CSWX			
FRAME SIZE	mm	90.0			
	in	3.54			
MOTOR WINDING		V23 / V43		V24 / V44	
NUT/SCREW		RN05XR	RN10	RN05XR	RN10
SCREW LEAD	mm	5.0	10.0	5.0	10.0
PEAK FORCE	kN	15.8	7.9	18.0	10.5
	lbf	3560	1780	4047	2350
MAX. VELOCITY	mm/sec	342 / 350	683 / 700	350	700
	in/sec	13.5 / 13.8	26.9 / 27.6	13.8	27.6
SCREW DLR (DYNAMIC LOAD RATING)	kN	91.7	76.4	91.7	76.4
	lbf	20,623	17,175	20,623	17,175
NOMINAL BACK DRIVE FORCE	N	405	205	405	205
	lbf	91	46	91	46
WEIGHT*	kg	10.9	10.9	11.4	11.4
	lbf	24.0	24.0	25.1	25.1
STROKE	mm	160	160	160	160
	in	6.3	6.3	6.3	6.3
BASE INERTIA	kg-cm ²	5.5	5.5	6.5	6.5
	lb-in	1.9	1.9	2.2	2.2
MAX. SIDE LOAD (150 mm)	N	75			
	lbf	17			
AMBIENT TEMP ** RANGE	°C	0 to 50			
	°F	32 to 122			
IP RATING	Standard IP65 (static)				
AGENCY LISTINGS	 				

WEIGHT SUMMARY

Stroke		Weight		
			Min.	Max.
160	mm	kg	10.24	12.84
	6.3 in	lb	22.57	28.31
200	mm	kg	10.96	13.64
	7.9 in	lb	24.16	30.07
250	mm	kg	11.86	14.64
	9.8 in	lb	26.14	32.28
300	mm	kg	12.76	15.64
	11.8 in	lb	28.12	34.48

Table 2: CSWX Weights

	Actuator Base Weight*	Add For Head Options			Round Rod Add For Stroke Length			Double D Rod Add For Stroke Length		
		Round Rod +94mm Head	Dbl-D +90mm Head	Dbl-D +94mm Head	200 mm (7.9 in)	250 mm (9.8 in)	300 mm (11.8)	200 mm (7.9 in)	250 mm (9.8 in)	300 mm (11.8)
kg	9.661	0.028	0.238	0.273	0.72	1.62	2.52	0.80	1.80	2.80
lb	21.3	0.06	0.52	0.6	1.59	3.57	5.56	1.76	3.97	6.17

*3 Stack Motor, Round Rod, 90mm Head, RN05, 160mm Stroke

	Add For Screw Type		Add For Feedback Device					Add For Option			
	RN05xR	RN10	Kuka	ABB	Fanuc A1000/A128	Fanuc A64 Covered	Sick	4-Stack Motor	Brake	Water Cooling	Trunnion
kg	0.066	0.076	0.816	0.864	0.576	0.933	0.66	0.63	0.505	0.183	0.579
lb	0.14	0.17	1.8	1.91	1.27	2.06	1.46	1.39	1.11	0.4	1.28

ServoWeld CSWX - Integrated Motor Actuator

Table 3: Motor Specifications:

SERIES		CSW_				
MOTOR WINDING / MOTOR VOLTAGE		_V23	_V43	_V24	_V44	
TORQUE CONSTANT (K_t)	N-m/A Peak	0.66	1.27	0.64	1.28	
	in-lb/A Peak	5.8	11.3	5.7	11.4	
VOLTAGE CONSTANT (K_e)		V/Krpm Peak	79.8	154	77.6	155.1
STALL TORQUE	Radiant Cooled	N-m	4.3	4.3	5.7	5.7
		in-lb	38.1	38.1	50.1	50.1
	Water Cooled	N-m	9.7	9.7	13.4	13.4
		in-lb	86.1	86.1	118.1	118.1
CONTINUOUS STALL CURRENT	Radiant Cooled	A_{RMS}	5.2	2.6	7.2	3.6
	Water Cooled	A_{RMS}	12.3	6.1	17.3	8.7
PEAK TORQUE		N-m	16.6	16.6	21.9	21.9
		in-lb	146.8	146.8	194.1	194.1
PEAK CURRENT		A_{RMS}	20.3	10.1	29.0	14.5
RESISTANCE		Ohms	2.07	8.28	1.14	4.56
INDUCTANCE		mH	3.80	15.00	2.42	9.82
BUS VOLTAGE		V_{RMS}	230	460	230	460
SPEED @ RATED V		RPM	4100	4200	4200	4200
NO. OF POLES			8	8	8	8

MOTOR WINDING
 _V23
 _V43 = 3 Stack Motor

 _V24
 _V44 = 4 Stack Motor

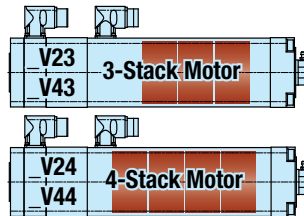

SIDE LOADING

Some weld gun designs may subject the actuator to excessive side loading reducing overall service life. Measures are required, especially in "C" style designs, to limit side loading. For life optimization Tolomatic recommends side loads less than indicated in the graph below.

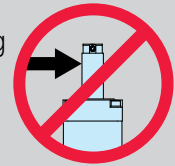

CSW_ SIDE LOAD SPECIFICATIONS

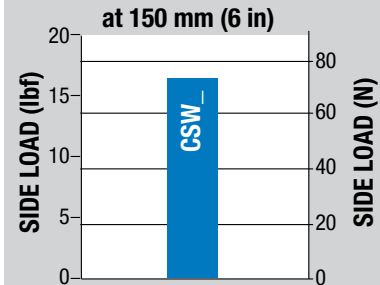

BRAKE CONSIDERATIONS

An un-powered SW will require a brake to maintain its position if the force on the actuator exceeds Back Drive Force listed in Table 1.

A brake can be used with the actuator to keep it from backdriving, typically in vertical applications. A brake may be used for safety reasons or for energy savings allowing the actuator to hold position when un-powered.

NOTE: The optional Spring-Applied / Electronically-Released Brake requires 24V power.

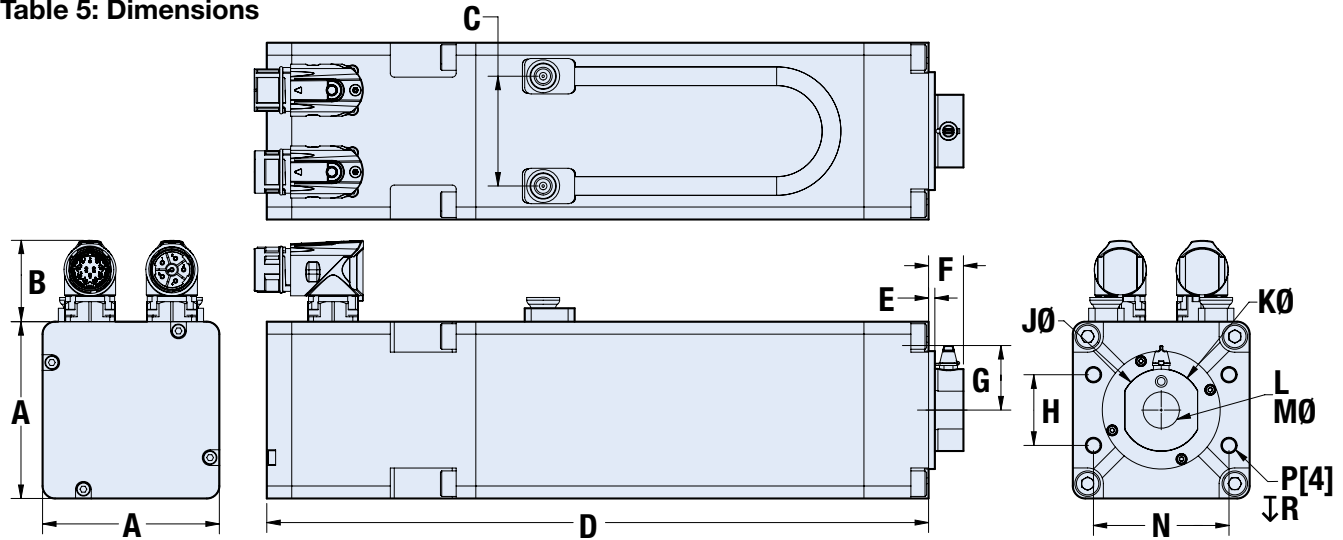

Table 4: Brake Specifications:

	SERIES	CSW_
ROTOR INERTIA	gm-cm ²	260
	oz-in ²	1.422
CURRENT	Amp	0.67
HOLDING TORQUE	N-m	5.0
	in-lb	44
ENGAGE TIME	mSec	35
ENGAGE TIME WITH DIODE	mSec	80
DISENGAGE TIME	mSec	25
VOLTAGE	Vdc	24

CSWX Dimensions

Table 5: Dimensions



	CSWX3
A	90.00
B	41.41
C	55.88
D	396.8
E	3.2
F	17.8
G	32.86
H	36.00
J	42.00

Dimensions in millimeters

	CSWX3
K	41.70
L	M20X1.5-6H 40.0
M	60.00
N	69.00
P	M8X1.25 X 12mm
R	20.0

	CSWX3
A	3.543
B	1.630
C	2.200
D	15.62
E	0.13
F	0.70
G	1.294
H	1.417
J	1.654

Dimensions in inches

	CSWX3
K	1.642
L	M20X1.5-6H 1.58
M	2.362
N	2.717
P	M8X1.25 X 12mm
R	0.79

CSWX Performance

Graph 1: Performance:

ESTIMATED LIFE

(with proper installation & maintenance)

FORCE (Thousands, lbf)

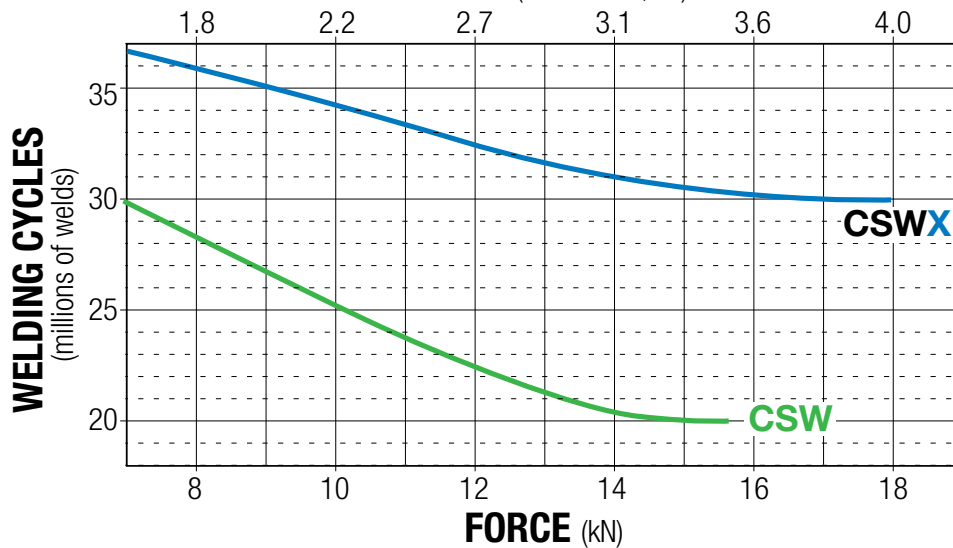

Complete Verification Testing is Performed on Every Actuator

EVERY SERVOWELD ACTUATOR HAS TO PASS RIGOROUS TESTING AT OUR FACTORY.

We verify the performance of each individual unit before delivery to ensure they conform to Tolomatic's high standard of performance.



Functional unit testing for hundreds of cycles quantifies stroke, length, torque under no load, input current vs force standard deviation.

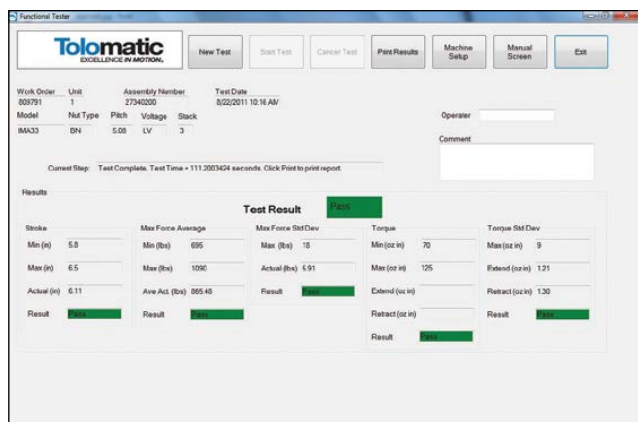

Testing parameter results in progress for the Functional Test procedure.



Final system test ensures the feedback device is properly aligned with the ServoWeld motor poles.

1. High POT (High Potential/High Voltage Test)

This standard electric motor test procedure is a 3-part test that checks the insulation system of the assembly to verify proper armature and thermal wire insulation.

2. Electronic phasing of ServoWeld® and feedback device (Encoder, Resolver, Feedback Device)

Using a fixed current and a specially designed fixture the feedback device is physically and electronically aligned relative to the phasing of the Tolomatic motor.

3. Functional Testing

Performed with Tolomatic motion control components and dedicated data acquisition equipment. Operated for hundred of cycles, this test quantifies these parameters - stroke length, torque under no load, input current vs force average, input current vs force standard deviation - using an electronic load cell in conjunction with data acquisition equipment.

4. Tolomatic System Test

Using a single-axis control unit the test ensures that the feedback device is properly aligned with the poles of the Tolomatic motor.

ServoWeld Application Guidelines

SIDE LOADING: Weld gun designs may subject the actuator to excessive side loading, reducing overall service life. The GSWA33 and CSW(x) Guided actuators will accommodate side loading caused by the mass of the electrode, misaligned weld tips and tip skid. For other ServoWeld configurations additional measures are required to limit side loading, especially in “C” style gun designs. For maximum service life, external guiding is recommended to minimize side loading to the thrust rod and provide consistent weld gun alignment throughout the service life. Reference the side load capacity charts in the GSWA, SWA/SWB, and CSW(x) manuals and/or brochures.

THRUST ROD WIPER/SCRAPER: For maximum service life, measures should be taken to reduce/eliminate contamination, weld slag, and water in the thrust rod wiper/scraper interface area. Implementation of industrial thrust rod boot and/or deflective device can be effectively utilized in this area.

CABLES: Shielded power & feedback cables are recommended to minimize electrical noise/grounding issues. Electrical noise or inadequate grounding can corrupt the feedback device signal.

RSW SERVO SYSTEM CALIBRATION: RSW weld gun servo system consists of robot 7th axis amplifier, robot feedback device, robot RSW software, weld gun chassis, & ServoWeld.

For optimal RSW weld gun servo system performance the calibration process should include maximum weld tip force from the production weld schedule, tip dress force, and multiple weld tip forces in-between. Utilizing all the available robot manufacturer force table inputs will provide best RSW weld gun servo system performance. The same weld tip part contact speed should be used for both RSW weld gun servo system calibration and production weld schedule.

WELD TIP / PART CONTACT SPEED: Tolomatic testing confirms the highest ServoWeld repeatability (**INPUT**

CURRENT versus **OUTPUT FORCE**) at a weld tip part contact speed of 25mm/second or less. Speeds greater than 25mm/second can create “impact contribution” to the weld force. This impact contribution to the weld force deteriorates prior to completion of the weld cycle.

ROBOT CARRIED APPLICATIONS: Robot carried RSW gun applications have reduced exposure to water pooling/water ingress by virtue of the continuous robot movement and various RSW gun positions. In addition, in robot carried applications positioning of the RSW gun can be programmed as part of the weld cap change program/routine to eliminate ServoWeld exposure to water. (ServoWeld above weld caps)

ROBOT MANUFACTURER SERVO FILE: Robot manufacturer servo parameter files for operation of ServoWeld are available only from the robot manufacturer. Each robot manufacturer creates 3rd party motor servo parameter files, validates operation of ServoWeld via their 7th axis, and maintains servo motor parameter file for operation of ServoWeld.

TOOL CHANGER APPLICATIONS: Weld gun storage fixture in cell should position weld gun so movable electrode is not loading ServoWeld thrust rod - back driving the ServoWeld. Weld gun tips should be positioned to weld gun closed at low force prior to disconnect from robot/tool changer. Consider ServoWeld configured with integral brake option.

FIXED / PEDESTAL APPLICATIONS: One of the more challenging RSW applications is a pedestal RSW gun, ServoWeld mounted vertical – thrust rod up. Measures should be taken to reduce and/or eliminate the ServoWeld to water exposure, water pooling/spray in the access areas of the ServoWeld unit to maximize overall service life.

ServoWeld CSWX Integrated Motor Actuators

Ordering

MODEL SELECTION (MUST BE IN THIS ORDER)

C S W X 3 S V 2 4 W 2 F 1 C S 1 R N 1 0 S 2 0 0 A 2 H F 1 - F A

MODEL

CSWX Compact ServoWeld X

SIZE

3 3 Series; 90 mm square

THERMAL PROTECTION

F Fanuc Proprietary
R 600 ohm resistor in series with temperature switch
P PT1000
S Standard, temp. switch normally closed

MOTOR VOLTAGE & STACKS

23 230 Vac, Motor Voltage, 3 Stack Winding
43 460 Vac, Motor Voltage, 3 Stack Winding
24 230 Vac, Motor Voltage, 4 Stack Winding
44 460 Vac, Motor Voltage, 4 Stack Winding

COOLING

R1 Radiant Cooled
W1 Water Cooling, G 1/4 Thread, Connector Side
W2 Water Cooling, G 1/4 Thread, Opposite Connector

FEEDBACK, CONNECTOR, WIRING

A1 ABB Resolver
C1 Comau Resolver
E1 Emerson CT Hiperface
F1 Fanuc a128
F2 Fanuc a64
M1 Motoman Absolute
N1 Nachi Absolute FD11 Series
R1 Rockwell Automation Hiperface
R2 Rockwell Automation Hiperface DSL
W1 Kawasaki Absolute E Series
XX Special

FEEDBACK SUPPLIED BY:

CS Customer Supplied
TS Tolomatic Supplied

BRAKE OPTION

1 NO Brake
2 24V Brake
3 90V Brake

SCREW LEAD

RX05 Roller Nut, 5 mm lead, Extended Roller Nut
RN10 Roller Nut, 10 mm lead

STROKE LENGTH

S160 160mm (6.3") Stroke
S200 200mm (7.9") Stroke
S250 250mm (9.8") Stroke
S300 300mm (11.8") Stroke

ROD END OPTIONS

A Female M20
B Female M16
C 20 mm Spherical Rod Eye
D 16 mm Spherical Rod Eye

ROD-TYPE

1 Round
2 Double D (Anti-rotate)

ACTUATOR MOUNTING

HF1 Standard Head 4 M8x1.25 tapped holes, 69mmx36mm pattern
UN1 Universal head 94mm square Mid Trunnion (contact Tolomatic)

ADDITIONAL OPTIONS

(Each separated by hyphen)
FA Force Feedback
 Manual Override
 (Contact Tolomatic)



Not all codes listed are compatible with all options.

Call Tolomatic 1-800-328-2174 to determine available options and accessories based on your application requirements.

The Tolomatic Difference Expect More From the Industry Leader:



INNOVATIVE PRODUCTS

Solutions with Endurance TechnologySM for challenging applications.



FAST DELIVERY

Built-to-order with configurable stroke lengths and flexible mounting options.

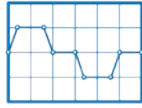

ACTUATOR SIZING

Size and select electric actuators with our online software.



YOUR MOTOR HERE[®]

Match your motor to compatible mounting plates with Tolomatic actuators.



CAD LIBRARY

Download 2D or 3D CAD files for Tolomatic products.



TECHNICAL SUPPORT

Get a question answered or request a virtual design consultation with one of our engineers.

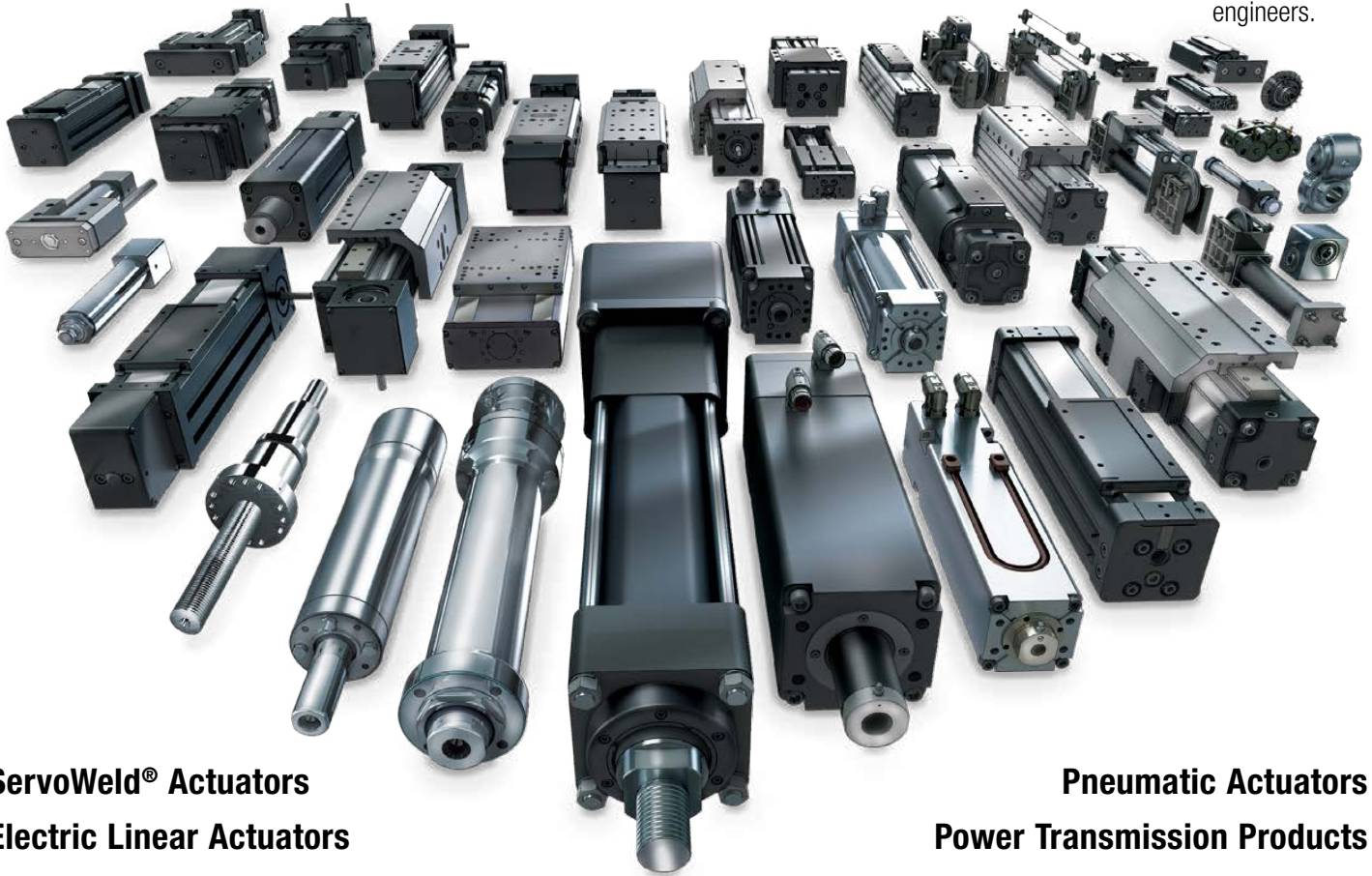

ServoWeld[®] Actuators
Electric Linear Actuators

Pneumatic Actuators
Power Transmission Products



MADE IN U.S.A.

TolomaticTM
EXCELLENCE *IN MOTION*

COMPANY WITH
QUALITY SYSTEM
CERTIFIED BY DNV
= ISO 9001 =
Certified site: Hamel, MN

USA - Headquarters

Tolomatic Inc.
3800 County Road 116
Hamel, MN 55340, USA
Phone: (763) 478-8000
Toll-Free: **1-800-328-2174**
sales@tolomatic.com
www.tolomatic.com

MEXICO

Centro de Servicio
Parque Tecnológico Innovación
Int. 23, Lateral Estatal 431,
Santiago de Querétaro,
El Marqués, México, C.P. 76246
Phone: +1 (763) 478-8000
help@tolomatic.com

EUROPE

Tolomatic Europe GmbH
Elisabethenstr. 20
65428 Rüsselsheim
Germany
Phone: +49 6142 17604-0
help@tolomatic.eu
www.tolomatic.com/de-de

CHINA

Tolomatic Automation Products (Suzhou) Co. Ltd.
No. 60 Chuangye Street, Building 2
Huqiu District, SND Suzhou
Jiangsu 215011 - P.R. China
Phone: +86 (512) 6750-8506
Tolomatic_China@tolomatic.com

All brand and product names are trademarks or registered trademarks of their respective owners. Information in this document is believed accurate at time of printing. However, Tolomatic assumes no responsibility for its use or for any errors

that may appear in this document. Tolomatic reserves the right to change the design or operation of the equipment described herein and any associated motion products without notice. Information in this document is subject to change without notice.

Visit www.tolomatic.com for the most up-to-date technical information