

Magnetically Coupled Cylinders

MG(A,B or C)-100 (1-Inch Bore)
 MG(A,B or C)-025 (1/4-Inch Bore)
 MG(A,B or C)-038 (3/8-Inch Bore)
 MG(A,B or C)-062 (5/8-Inch Bore)

For Models With:
 A, B, or C Magnetic Coupling Strengths

(12-12-2022) MG25, MG038, AND MG062 ARE DISCONTINUED PRODUCTS. PARTS SHEET IS FOR REPAIR INSTRUCTIONS ONLY. Parts listing is for reference only. All parts listed are limited to stock on hand. Contact Tolomatic regarding availability.

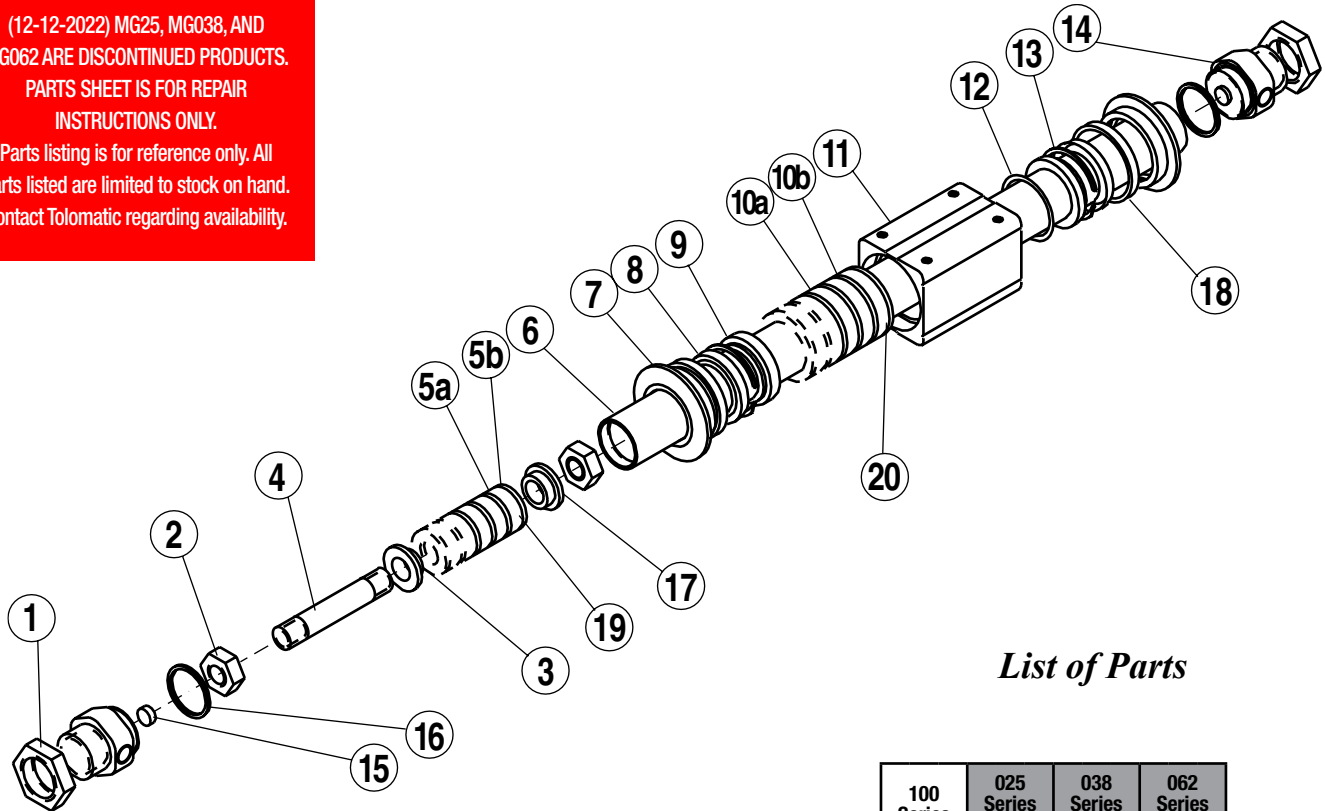

List of Parts

Item	Part No. or Config. Code	Description	100 Series			025 Series (Disc.)			038 Series (Disc.)			062 Series (Disc.)		
			A	B	C	A	B	C	A	B	C	A	B	C
1.	2406-1020	Nut, 3/8-24				2	2	2	2	2	2	2	2	2
	2410-1020	Nut, 1-12 UNF	2	2	2									
2.	2402-1027	Jam Nut, #1-64				2	2	2						
	2403-1027	Jam Nut, #2-56							2	2	2			
	2406-1027	Jam Nut, #1/4-20										2	2	2
	1014-1050	Jam Nut, #1/2-20	2	2	2									
***3.	2402-1003	O-Ring				1	1	1						
	2403-1070	T-Seal							1	1	1			
	2406-1070	T-Seal										1	1	1
	2410-1070	T-Seal	1	1	1									
4.	2402-1025	Piston Stud				1	1							
	2402-1076	Piston Stud						1						
	2403-1025	Piston Stud							1	1				
	2403-1076	Piston Stud									1			
	2406-1025	Piston Stud										1	1	
	2406-1076	Piston Stud												1
*5a.	2402-1008	Inside Magnet				4	5	6						
	2403-1008	Inside Magnet							2	3	4			
	2406-1008	Inside Magnet										2	3	4
	2410-1008	Inside Magnet	2	3	4									

*Available only with complete Piston Assembly consult factory for part number.

**Available only with complete Carrier Assembly consult factory for part number.

***Denotes Repair Kit items. Repair Kit 2410-9023 (100 Series) contain items 3, 8, 9, 10, 18, 19, and 20. 2402-9023 (025 Series), 2403-9023 (038 Series), 2406-9023 (062 Series) repair kits have been discontinued.

Item	Part No. or Config. Code	Description	100 Series			025 Series (Disc.)			038 Series (Disc.)			062 Series (Disc.)		
			A	B	C	A	B	C	A	B	C	A	B	C
*5b.	2402-1009	Inside Magnet				4	5	7						
	2403-1009	Inside Magnet							3	4	5			
	2406-1009	Inside Magnet										3	4	5
	2410-1009	Inside Magnet	3	4	5									
Specify Stroke														
6.	2402-1017	Machine Tube				1	1							
	2402-1100	Machine Tube						1						
	2403-1017	Machine Tube						1	1					
	2403-1100	Machine Tube								1				
	2406-1017	Machine Tube									1	1		
	2406-1100	Machine Tube												1
	2410-1017	Machine Tube	1	1										
***7.	2403-1018	End Cap							2	2	2			
	2406-1018	End Cap										2	2	2
	2410-1018	End Cap	2	2	2									
***8.	2402-1016	Wiper Seal				2	2	2						
	2403-1016	Wiper Seal							2	2	2			
	2406-1016	Wiper Seal										2	2	2
	2410-1016	Wiper Seal	2	2	2									
***9.	2402-1010	Wear Ring				2	2	2						
	2403-1010	Wear Ring							2	2	2			
	2406-1010	Wear Ring										2	2	2
	2410-1010	Wear Ring	2	2	2									
**10a.	2402-1013	Outside Magnet				4	5	6						
	2403-1013	Outside Magnet							2	3	4			
	2406-1013	Outside Magnet										2	3	4
	2410-1013	Outside Magnet	2	3	4									
**10b.	2402-1014	Outside Washer				5	6	7						
	2403-1014	Outside Washer							3	4	5			
	2406-1014	Outside Washer										3	4	5
	2410-1014	Outside Washer	3	4	5									
**11.	2402-1024	Machined Carrier				1	1							
	2402-1075	Machined Carrier						1						
	2403-1024	Machined Carrier						1	1					
	2403-1075	Machined Carrier								1				
	2406-1024	Machined Carrier										1	1	
	2406-1075	Machined Carrier												1
	2410-1024	Machined Carrier	1	1										
12.	1001-1021	O-Ring				2	2	2						
	2402-1101	O-Ring				2	2	2						
	1004-1274	O-Ring							2	2	2			
	1001-1131	O-Ring										2	2	2
	2410-1015	O-Ring	1	1	1									
13.	2402-1096	Retaining Ring				2	2	2						
	2403-1096	Retaining Ring							2	2	2			
	2406-1096	Retaining Ring										2	2	2
	2410-1096	Retaining Ring	2	2	2									
14.	2402-1002	Machined Head				2	2	2						
	2403-1002	Machined Head							2	2	2			
	2406-1002	Machined Head										2	2	2
	2410-1002	Machined Head	2	2	2									
***15.	2402-1021	Bumper				2	2	2	2	2	2			
	2406-1021	Bumper										2	2	2
	1812-1030	Bumper	2	2	2									

Item	Part No. or Config. Code	Description	100 Series			025 Series (Disc.)			038 Series (Disc.)			062 Series (Disc.)		
			A	B	C	A	B	C	A	B	C	A	B	C
***16.	2402-1022	Crush Ring				2	2	2						
	2403-1022	Crush Ring							2	2	2			
	2406-1022	Crush Ring										2	2	2
	2410-1022	Crush Ring	2	2	2									
***17.	2402-1026	Piston Bearing				2	2	2						
	2403-1026	Piston Bearing							2	2	2			
	2406-1026	Piston Bearing										2	2	2
	2410-1026	Piston Bearing	2	2	2									
18.	2403-1036	Gland Ring							2	2	2			
	2406-1036	Gland Ring										2	2	2
*19.	2402-1078	Insider Spacer									1			
	2403-1078	Insider Spacer										1		
	2406-1078	Insider Spacer											1	
	2410-1078	Insider Spacer	1											
**20.	2402-1079	Outside Spacer									1			
	2403-1079	Outside Spacer										1		
	2406-1079	Outside Spacer											1	
	2410-1079	Outside Spacer	1											

(12-12-2022) MG25, MG038, AND MG062 ARE DISCONTINUED PRODUCTS. PARTS SHEET IS FOR REPAIR INSTRUCTIONS ONLY. Parts listing is for reference only. All parts listed are limited to stock on hand. Contact Tolomatic regarding availability.

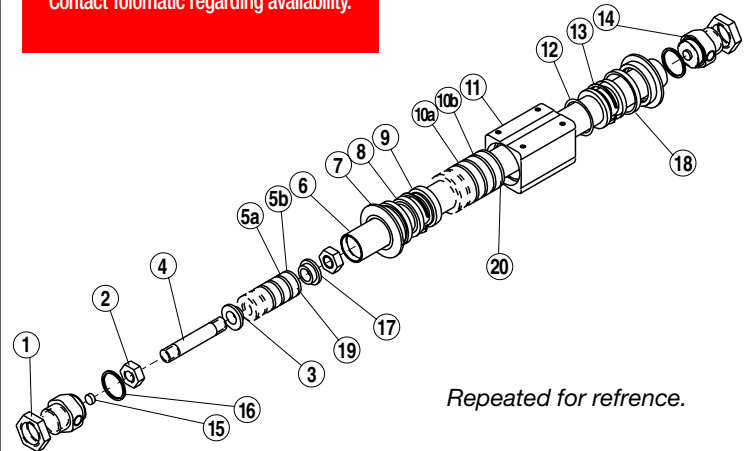

*Available only with complete Piston Assembly.
 **Available only with complete Carrier Assembly.
 ***Denotes Repair Kit items. Repair Kit 2410-9023 (100 Series) contain items 3, 8, 9, 10, 18, 19, and 20.
 2402-9023 (025 Series), 2403-9023 (038 Series), 2406-9023 (062 Series) repair kits have been discontinued.

(12-12-2022) MG25, MG038, AND MG062 ARE DISCONTINUED PRODUCTS. PARTS SHEET IS FOR REPAIR INSTRUCTIONS ONLY.

Parts listing is for reference only. All parts listed are limited to stock on hand. Contact Tolomatic regarding availability.

1. Unscrew the Machined Head (#14) from one end of the cylinder and set aside.
2. Uncouple the carrier assembly from the piston assembly and slide the carrier assembly off of the Machined Tube (#6). Do this by sticking a rod into the cylinder tube and pushing the piston back toward the end of the cylinder while pulling the carrier assembly off of the open end of the cylinder. **WARNING: If the piston and carrier assemblies are not uncoupled prior to removing the assemblies from the cylinder, the piston assembly will be stuck inside the carrier.**
3. Pry the End Caps (#7) off of both ends of the Machined Carrier (#11) and throw away.
4. Remove the Wiper Seals (#8) from the inside of each end of the carrier and throw away. For 3/8" and 5/8" models, remove the Gland Rings (#18) and set aside for reassembly.
5. Remove the Wear Ring (#9) from one end of the carrier by removing the screws that hold it in place. Replace with a new wear ring and fasten with the old screws using Loctite #242.
6. Turn the carrier over and remove the Wear Ring (#9) from the opposite end by removing the screws that hold it in place. Replace with a new wear ring and fasten with the old screws using Loctite #242.
7. For 1/4" models:
Drop in a new Wiper Seal (#8), lip side out, into one end of the carrier. Repeat this process for the opposite end of the carrier and set aside for reassembly.

For 1" models:
Drop in a new Wiper Seal (#8), lip side out, into one end of the carrier and snap a new End Cap (#7) into place over the wiper seal. Repeat this process for the opposite end of the carrier and set aside for reassembly.

For 3/8" and 5/8" models:
Press a new Wiper Seal (#8) into one of the old gland rings and drop into one end of the carrier, lip side out. Snap a new End Cap (#7) into place over the gland ring. Repeat this process for the opposite end of the carrier and set aside for reassembly.
8. Remove the piston assembly from inside of the Machined Tube (#6).
9. Unscrew the Jam Nut (#2) from one end of the Piston Stud (#4).
10. Remove all parts from the piston stud so that only the Jam Nut (#2) on one end remains. Slide a new Piston Bearing (#17) onto the piston stud until it butts up against the jam nut. Slide the magnet assembly back onto the stud and apply Loctite #242 onto the remaining stud length and screw threads. Slide a new T-Seal/O-Ring (#3) and Piston Bearing (#17) onto the piston stud. Replace the jam nut and tighten.
11. To ensure that the piston and carrier will couple correctly when reassembled, set the piston stud on one of the outside grooves in the carrier. If the magnets hold the piston centered on the carrier, mark which end of the carrier is coupled with the piston end containing the t-seal/o-ring.
12. Uncouple the piston and carrier assemblies and lubricate the piston assembly with Magnalube-G. Place the assembly back into the machined tube with the end that has the T-Seal/O-Ring (#3) first.
13. Lubricate the inside of the carrier assembly with Magnalube-G and slide the assembly onto the machined tube, marked end first.
14. Remove the Bumper (#15) from the recess in the Machined Head (#14) and glue a new bumper into its place using Loctite #495 adhesive.
15. Remove the Crush Ring (#16) from the groove in the Machined Head (#14) and replace with a new crush ring.
16. Place Loctite sealant on the threads of the Machined Head (#14) and screw into the end of the cylinder tube. Tighten one extra turn, making sure the port lines up exactly with the port in the other head.
17. Couple the carrier assembly to the piston assembly by sliding the carrier to the opposite end of the cylinder tube. Push the carrier firmly toward the head until the carrier becomes centered with the piston. **Note: If the carrier hits the head, the carrier and piston are not coupled correctly.** Remove the head, uncouple the carrier from the piston, and slide the carrier off of the machined tube. Turn the carrier around and slide back onto the machined tube. The piston and carrier should now couple correctly.
18. Test the repair by cycling the cylinder back and forth two times at full flow.

CODE	SWITCH TYPE
BT	(Form C Reed Switch with 5-meter lead)
BU	(Form C Reed Switch with 2-meter lead and QD)
BM	(Form C Reed Switch with 5-meter lead and QD)
RT	(Form A Reed Switch with 5-meter lead)
RU	(Form A Reed Switch with 2-meter lead and QD)
RM	(Form A Reed Switch with 5-meter lead and QD)
CT	(TRIAC Switch with 5-meter lead)
CU	(TRIAC Switch with 2-meter lead and QD)
CM	(TRIAC Switch with 5-meter lead and QD)
KT	(Hall-effect Switch (Sinking) 5-meter lead)
KU	(Hall-effect Switch (Sinking) 2-meter lead and QD)
KM	(Hall-effect Switch (Sinking) 5-meter lead and QD)
TT	(Hall-effect Switch (Sourcing) 5-meter lead)
TU	(Hall-effect Switch (Sourcing) 2-meter lead and QD)
TM	(Hall-effect Switch (Sourcing) 5-meter lead and QD)

19. Switch Option

NOTE: Form A Reed Switches should not be used in TTL logic circuits. A voltage drop caused by the L.E.D. indicator will result. For applications where TTL circuits are used, please contact the factory.

WARNING: An ohmmeter is recommended for testing Reed Switches. NEVER use an incandescent light bulb as a high current rush may damage the switch.

Reed and TRIAC switches are only recommended for signalling position, not directly powering solenoids. For shifting a solenoid, a relay or resistor is recommended between it and the Reed Switch. Switch ratings must not be exceeded at any time.

NOTE: The side of the switch with the groove indicates the sensing surface. This must face toward the magnet.

For complete Switch Performance Data, refer to the Tolomatic Fluid Power Products Catalog #9900-4000.

TO ORDER RETROFIT KITS:

SW(then the model number and base size, and code for type of switch needed.

EXAMPLE: SWMGB062BT

Where SW is the switch kit, MGB is the model, 062 is the 5/8" size, and BT is a Form A Reed Switch with 5-meter lead.

An Important Note Regarding Field Retrofit of Quick-Disconnect Couplers:
 If replacing a Quick-Disconnect switch manufactured before 7-1-97 it will also be necessary to replace or rewire the female-end coupler with the in-line splice.

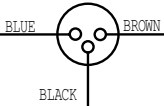

REED SWITCH FORM A
 LABEL COLOR: RED
 10VA MAX. 200 Vdc
 500mA Max. Current

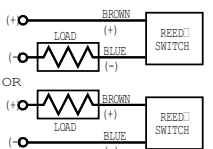

REED SWITCH FORM C
 LABEL COLOR: YELLOW
 120 Vdc/120 Vac MAX.
 250mA Max. Current

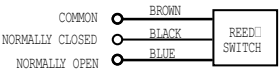

HALL-EFFECT SWITCH (SOURCING)
 LABEL COLOR: WHITE
 Input Voltage: 5-25 VDC only
 Output Current: 200 mA Max.

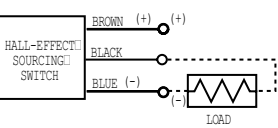

HALL-EFFECT SWITCH (SINKING)
 LABEL COLOR: GREEN
 Input Voltage: 5-25 VDC only
 Output Current: 200 mA Max.

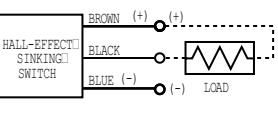

TRIAC SWITCH
 LABEL COLOR: BLUE
 Max. 1Amp. Cont. Current @ 86°F
 Max. .5Amp. Cont. Current @ 140°F
 Peak surge current 10Amp.

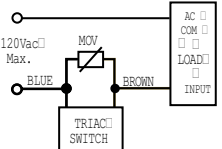

CONFIG. CODE ORDERING	
Mounting Hardware & FE conn. included	
DESCRIPTION	CODE
Switch Kit, Reed, Form C, 5m	BT
Switch Kit, Reed, Form C, Male Conn.	BM
Switch Kit, Reed, Form A, 5m	RT
Switch Kit, Reed, Form A, Male Conn.	RM
Switch Kit, Triac, 5m	CT
Switch Kit, Triac, Male Conn.	CM
Switch Kit, Hall-effect, Sinking, 5m	KT
Switch Kit, Hall-effect, Sinking, Male Conn.	KM
Switch Kit, Hall-effect, Sourcing, 5m	TT
Switch Kit, Hall-effect, Sourcing, Male Conn.	TM

NOTE: When ordered female connector & all mounting hardware is included

All Switch Kits come with 1 switch and mounting hardware.
 Female Connector 5M



3800 County Road 116, Hamel, MN 55340 USA
 http://www.Tolomatic.com • Email: Help@Tolomatic.com
 Phone: (763) 478-8000 • Fax: (763) 478-8080 • Toll Free: 1-800-328-2174

COMPANY WITH
 QUALITY SYSTEM
 CERTIFIED BY DNV
 = ISO 9001 =

All brand and product names are trademarks or registered trademarks of their respective owners. Information in this document is believed accurate at time of printing. However, Tolomatic assumes no responsibility for its use or for any errors that may appear in this document. Tolomatic reserves the right to change the design or operation of the equipment described herein and any associated motion products without notice. Information in this document is subject to change without notice.